

# COOKOLOGY

CDO900BK

Built-in Electric Oven

User Manual



Product picture only for reference

# CONTENTS & INTRODUCTION

---

## CONTENTS

- SAFETY
- USING THE PRODUCT
- CLEANING
- INSTALLATION INSTRUCTIONS

Our policy is one of constant development and improvement, therefore we cannot guarantee the strict accuracy of all of our illustrations and specifications - changes may have been made subsequent to publishing.

## INTRODUCTION

**Thank you for buying this appliance from us.**

This guide book is designed to help you through each step of owning your new oven, from installation to use. Please read it carefully before you start using your product, as we have endeavored to answer as many questions as possible, and provide you with as much support as we can.

Alternatively, general information, spares and service information are available from our website. The address is located on the back page of this book.

## WARRANTY

Your new appliance comes with our 12-month guarantee, protecting you against electrical and mechanical breakdown. For full terms & conditions of the manufacturer's guarantee.

In addition, you may wish to purchase an extended warranty. A leaflet explaining how to do this is included with your appliance.

# SAFETY

---

## **BEFORE USING THE PRODUCT**

Make sure that you have removed all packaging and wrapping. Some of the items inside this appliance may have additional wrapping.

## **GENERAL**

**WARNING!** - The appliance and its accessible parts become hot during use. Care should be taken to avoid touching heating elements. Children less than 8 years of age shall be kept away unless continuously supervised. This appliance can be used by children aged from 8 years and above and persons with reduced physical sensory or mental capabilities or lack of experience and knowledge if they have been given supervision or instruction concerning the use of the appliance in a safe way and understand the hazards involved. Children

shall not play with the appliance. Cleaning and user maintenance shall not be made by children without supervision.

## **WARNING!** -

Unattended cooking on a hob with fat or oil can be dangerous and may result in fire.

NEVER try to extinguish a fire with water, but switch off the appliance and then cover the flame with a lid or damp cloth.

**WARNING!** - Danger of fire: Do not store items on the cooking surfaces.

**WARNING!** - Servicing should be carried out only by authorised personnel.

- The appliance must never be disconnected from the mains supply during use, as this will seriously affect the safety

## SAFETY

---

and performance, particularly in relation to surface temperatures becoming hot and gas operated parts not working efficiently. The cooling fan (if fitted) is designed to run on after the control knob has been switched off.

- Do not spray aerosols in the vicinity of this appliance while it is in operation.
- Do not store or use flammable liquids or items in the vicinity of this appliance.
- Do not modify this appliance.

**CAUTION:** The use of a gas cooking appliance results in the production of heat, moisture and products of combustion in the room in which it is

installed. Ensure that the kitchen is well ventilated especially when the appliance is in use:

Prolonged intensive use of the appliance may call for additional ventilation, for example opening of a window, or more effective ventilation, for example increasing the level of mechanical ventilation where present.

Excess spillage must be removed before cleaning.

During pyrolytic cleaning, accessible parts may become hotter than normal. Young children should be kept away.

### **WARNING! -**

Do not operate the appliance without the glass door correctly closed.

## SAFETY

---

### **WARNING! -**

Never put items directly on the base of the oven or cover the oven base with foil, as this can cause the base element to overheat.

### **WARNING! -**

Do not modify the outer panels of this appliance in any way.

### **WARNING! -**

This appliance must be earthed.

### **WARNING! -**

Always allow the product to cool down before you change a bulb. There is a risk of electric shock, so always make sure you have turned off and unplugged your appliance before starting.

### **WARNING! -**

The top element gets extremely hot when in

use, so take extra care to avoid touching it.

**WARNING! -** Do not use harsh abrasive cleaners or sharp metal scrapers to clean the oven door glass since they can scratch the surface, which may well result in shattering of the glass.

**CAUTION:** This appliance is for cooking purposes only. It must not be used for other purposes, for example room heating.

### **WARNING! -**

If the supply cord is damaged, it must be replaced by the manufacturer, its service agent or similarly qualified persons in order to avoid a hazard.

# SAFETY

---

## **WARNING! -**

The steam cleaner is not to be used.

## **WARNING! -**

The appliance must not be installed behind a decorative door in order to avoid overheating.

## **OVEN / GRILL**

### **Do**

- Always take care when removing food from the oven as the area around the cavity may be hot.
- Always use oven gloves when handling any utensils that have been in the oven as they will be hot.
- Always make sure that the oven shelves are resting in the correct position between two runners. Do not place the oven shelves on top of the highest runner, as this is not stable and can lead to spillage or injury.
- Always use the Minute Minder (if fitted) if you are leaving the oven unattended - this reduces the risk of food burning.

### **Do Not**

- Never place items on the door while it is open.
- Never wrap foil around the oven shelves or allow foil to block the air flue.
- Never drape tea towels near the oven while it is on; this will cause a fire hazard.
- Never pull heavy items, such as turkeys or large joints of meat, out from the oven on the shelf, as they may overbalance and fall.

# USING THE GRILL - ELECTRIC

---

**Caution: Accessible parts may be hot when the grill is used - young children should be kept away.**

If cleaning the grill pan when it is hot, use oven gloves to move it.

Food for grilling should be positioned centrally on the trivet.

## Using the TOP Oven grill



**Important:** The grill door must be fully open when the grill is used.

Open the grill door. Turn the control knob to the required setting. For best cooking results, we recommend that you preheat the single grill for 5 minutes.

Push the grill pan towards the back of the shelf, to position it under the grill.

Turn the temperature knob to the MAX position or by selecting a higher or lower shelf position. For toast-ing, and for grilling foods such as bacon, sausages or steaks, use a higher shelf position. For thicker foods such as chops or chicken joint pieces, use a middle to low shelf position.

To switch off, turn the control knob to the off  position.

## Using aluminium foil

Using aluminium foil to cover the grill pan, or putting items wrapped in foil under the grill creates a fire hazard.

## The cooling fan

When the grill is switched on, the cooling fan comes on to keep the fascia and control knobs cool during grilling.

During use the fan may cycle on and off, this is normal.

# USING THE TOP OVEN - ELECTRIC (if fitted)

---

**When you are cooking keep children away from the vicinity of the oven.**

**Caution:** The top element gets extremely hot when in use, so take extra care to avoid touching it.

The top oven is a conventional oven.

Note: The top oven is not controlled by the programmer (if fitted).

## **To turn on the top oven**

Turn the temperature control knob until the required temperature is selected.

The red thermostat indicator will come on until the selected temperature is reached, and then go off; it will turn on and off periodically as the thermostat operates to maintain the selected temperature.

To switch off, return the top oven control knob to the off position.

**Important:** Never put items directly on the base of the oven, or cover the oven base with foil, as this may cause the element to overheat. Always position items on the shelf.

## **The cooling fan**

When the top oven is switched on, you will hear the cooling fan come on - this keeps the fascia and control knobs of the appliance cool during cooking.

## **Preheating**

The oven must be preheated when cooking frozen or chilled foods, and we recommend preheating for yeast mixtures, batters, soufflés, and whisked sponges.

Preheat the oven until the indicator light switches off for the first time, this will take up to 15 minutes depending on the temperature selected.

If you are not preheating the oven, the cooking times in the following guide may need to be extended, as they are based on a preheated oven.

## **Shelf positions**

There are 3 shelf positions which are counted from the bottom of the oven upwards, so shelf position 1 is the lowest.

When cooking frozen or chilled food, use the highest possible shelf position, while allowing some clearance between the food and the top element.

The oven shelf must be positioned with the up-stand at the rear of the oven and facing up. Position baking trays and roasting tins on the middle of the shelves, and leave one clear shelf position between shelves, to allow for circulation of heat.

## **When using the top oven**

When opening the oven door, care should be taken to avoid any possible contact with potentially hot air, since this may cause discomfort to people with sensitive skin. We recommend that you hold the underneath of the oven door handle.



# USING THE TOP OVEN - ELECTRIC (if fitted)

## TOP OVEN BAKING GUIDE

### Cooking times

These times are based on cooking in a preheated oven.

These cooking times are approximate, because the size and type of cooking dish will influence time as personal preferences.

### Shelf positions

As a general guide, when cooking frozen or chilled food, use the highest possible shelf position, while allowing some clearance between the food and the top element. Follow the instructions given on packaging.

### Cooking temperatures

The temperature settings and time given in the Baking Guides are based on dishes made with block margarine. If soft tub margarine is used, it may be necessary to reduce the temperature setting. If a recipe gives a different temperature setting to that shown in the guide, the recipe instruction should be followed.

Because the top oven is more compact, it may be necessary to reduce cooking temperatures specified in recipes by up to 20°C.

Use the baking guide as a reference for determining which temperatures to use.

Item	Temperature (°C)	Shelf Position	Approximate cooking time
Small cakes	160 - 170	2	20 - 25 mins
Victoria sandwich (2 x 180mm / 7")	160	1	20 - 25 mins
Swiss roll	200	1	8 - 12 mins
Semi rich fruit cake (180mm x 7")	140	1	2¼ - 2¾ hours
Scones	215	1	10 - 15 mins
Meringues	90 - 100	1	2 - 3 hours
Shortcrust pastry	200 - 210	1	Depends on size & type of cooking dish & also the filling
Puff / flaky pastry	200 - 210	1	
Choux pasrty	200 - 210	1	
Biscuits	160 - 200	2	10 - 20 mins
Sponge pudding	150	1	30 - 45 mins
Milk pudding	140	1	2 - 2½ hours

# USING THE MAIN OVEN - ELECTRIC

---

**Accessible parts may be hot when the oven is used. Young children should be kept away.**

## **To switch on the oven**

Turn the oven control knob(s) to the required setting.

The red thermostat indicator (if fitted) will come on until the selected temperature is reached and then go off; it will turn on and off periodically as the thermostat operates to maintain the selected temperature.

To switch off, return the control knob to the off  position.

## **When using the oven**

As part of the cooking process, hot air is expelled through a vent in the oven. When opening the oven door, care should be taken to avoid any possible contact with potentially hot air, since this may cause discomfort to people with sensitive skin. We recommend that you hold the underneath of the oven door handle.

## **PREHEATING**

### **Fanned oven**

When cooking sensitive items such as soufflé and Yorkshire puddings or, when cooking bread, we recommend that the oven is preheated until the neon switches off for the first time. For any other types of cooking, a preheat may not be required.

### **Conventional oven**

Preheating is always required

## **Manual Operation (fanned only)**

### **The cooling fan**

The cooling fan may operate when the main oven is on and may continue to operate for a period after the oven has been switched off.

## **OVEN FURNITURE**

### **Oven shelves**

The oven shelf must be positioned with the upstand at the rear of the oven and facing upwards.

Position baking trays and roasting tins on the middle of the shelves.

### **Baking tray and roasting tins**

For best cooked results and even browning, the recommended size baking trays and roasting tins that should be used are as follows;

Baking tray 473mm x 370mm

We recommend that you use good quality cookware. Poor quality trays and tins may warp when heated, leading to uneven baking results.

# USING THE MAIN OVEN - ELECTRIC

---

## Aluminium foil

Use foil only to cover food or cooking dishes, using foil to cover the shelves or oven base creates a fire hazard.

## Cooking with a fanned oven

**As this is a high efficiency oven, you may notice the emission of steam from the oven when the door is opened. Please take care when opening the door.**

If you are used to cooking with a conventional oven you will find a number of differences to cooking with a fan oven which will require a different approach:

There are no zones of heat in a fan oven as the convection fan at the back of the oven ensures an even temperature throughout the oven.

This makes it ideal for batch baking - eg; when planning a party as all the items will be cooked within the same length of time.

Foods are cooked at a lower temperature than a conventional oven, so conventional recipe temperature may have to be reduced. Please refer to the conversion chart.

Preheating is generally not necessary as a fan oven warms up quickly.

When batch baking foods that will rise during cooking - eg; bread - always ensure that enough space has been left between the shelves to allow for the rise.

## Notes:

When 2 or more shelves are being used, it may be necessary to increase the cooking time slightly.

Because the 2 oven shelves are wider than in many ovens, it is possible to cook 2 items per shelf - eg; 2 victoria sandwiches or 2 casseroles.

Although you need to keep in mind the points 'To help the air circulate freely' with careful choice of dishes and tins, it is possible to cook a complete meal, and perhaps something else for the freezer, in the oven at the same time.

When roasting meats, you will notice that fat splashing is reduced, which is due in part to the lower oven temperatures, and will help keep cleaning of the oven to a minimum.

Because a fan oven has an even temperature throughout the oven, there is no need to follow the shelf positions given in the baking guide.

# USING THE MAIN OVEN - ELECTRIC

---

There is no need to interchange dishes onto different shelves part way through cooking, as with a conventional oven.

## To help the air circulate freely

Position the shelves evenly within the oven and maintain a clearance from the oven roof and base.

If more than one cooking dish or baking tray is to be used on a shelf, leave a gap of at least 25mm between the items themselves and the oven interior.

## Defrosting and cooling in the main oven

To defrost frozen foods, turn the main oven control to the defrost position, place the food in the centre of the oven and close the door.

To cool foods after cooking prior to refrigerating or freezing, turn the main oven control to the defrost position and open the door.

## Defrosting times

Small or thin pieces of frozen fish or meat - eg; fish filets, prawns & mince will take approximately 1 - 2 hours.

Placing the food in a single layer will reduce the thawing time.

A medium sized casserole or stew will take approximately 3 - 4 hours.

A 1½kg/3lb oven ready chicken will take approximately 5 hours, remove the giblets as soon as possible.

## Be safe

Do not defrost stuffed poultry using this method.

Do not defrost larger joints of meat and poultry over 2kg/4lb using this method.

Never place uncooked food for defrosting next to cooked food which is to be cooled, as this can lead to cross contamination.

Defrosting meat, poultry, and fish can be accelerated using this method but make sure they are completely thawed before cooking thoroughly. Place meat and poultry on a trivet in a meat tin.

## MAIN OVEN BAKING GUIDE

### Cooking times & temperatures

The temperature settings and times given in the baking guide are based on dishes made with block margarine. If soft tub margarine is used it may be necessary to reduce the temperature setting.

Allow enough space between shelves for food that will rise during cooking.

Do not place items on the oven base as this will prevent air circulating freely.



# USING THE MAIN OVEN - ELECTRIC

Note: This is a high efficiency oven, therefore some adjustment will have to be made to conventional cooking temperatures. The table below shows conventional cooking temperatures, 'A' efficiency temperatures and gas marks. For optimum results,

conventional temperatures need to be converted to 'A' efficiency temperatures.

For example, an item which would normally cook at a conventional temperature of 180 °C, will now cook at the 'A' efficiency temperature of 160°C.

Conventional temperature (°C)	'A' Efficiency Oven (°C)
100	100
110	110
130	120
140	130
150	140
160	150
180-190	160
200	170
220	180
230	190
250	200

Food Type	Temperature settings (°C)		Time Approx.	Shelf Position
	Conv	Fanned		
Cakes				
Small cakes	170	160	15 - 25	3
Victoria sandwich	180	160	20 - 30	3
Semi rich fruit cake	150	125	2.5HRS - 3HRS	2
Christmas cake	150	125	2.5HRS - 3HRS	2
Puddings				
Bread and butter pudding	170	150	45 - 1hr	3
Fruit crumble	200	175	40 - 1hr	3
Miscellaneous				
Yorkshire pudding:				
large	220	200	40 - 48	4 - 5
small	220	200	15 - 20	4 - 5
Shortcrust pastry	200	180	Depends on filling	4 - 5

# USING THE MAIN OVEN - ELECTRIC

---

## Traditional fruit cakes

It should be remembered that ovens can vary over time, therefore cooking times can vary, making it difficult to be precise when baking fruit cakes.

It is necessary therefore, to test the cake before removal from the oven. Use a fine warmed skewer inserted into the centre of the cake. If the skewer comes out clean, then the cake is cooked.

- Follow the temperatures suggested in the recipe and then adjust accordingly to the conversion table.
- Do not attempt to make Christmas cakes larger than the oven can cope with, you should allow at least 25mm (1") space between the oven walls and the tin.
- Always follow the temperatures recommended in the recipe.
- To protect a very rich fruit cake during cooking, tie 2 layers of brown paper around the tin.
- We recommend that the cake tin is not stood on layers of brown paper, as this can hinder effective circulation of air.
- Do not use soft tub margarine for rich fruit cakes, unless specified in the recipe.
- Always use the correct size and shape of tin for the recipe quantities.

## Roast turkey

Roasting turkey involves cooking two different types of meat - the delicate light breast meat, which must not be allowed to dry out, and the darker leg meat, which takes longer to cook.

The turkey must be roasted long enough for the legs to cook, so frequent basting is necessary. The breast meat can be covered once browned.

- Always make sure that the turkey is completely thawed and that the giblets are removed before cooking.
- Turkey should be roasted at 160°C - 180°C (fanned) or 180°C - 200°C (conventional) for 20 minutes per 450g (1 lb), plus 20 minutes, unless packaging advises otherwise.
- The turkey can be open roasted, breast side down, for half of the cook time, and then turned over for the remainder of the cooking time.
- If the turkey is stuffed, add 5 minutes per 450g (1 lb) to the cooking time.
- If roasting turkey covered with foil, add 5 minutes per 450g (1 lb) to the cooking time.

To test if the turkey is cooked, push a fine skewer into the thickest part of the thigh. If the juices run clear, the turkey is cooked. If the juices are still pink, the turkey will need longer cooking.

# USING THE MAIN OVEN - ELECTRIC

## Roasting guide

The times given in the roasting guide are only approximate, because the size and age of the bird will influence cooking times as will the shape of a joint and the proportion of the bone.

Frozen meat should be thoroughly thawed before cooking. For large joints it is advisable to thaw over night.

Frozen poultry should be thoroughly thawed before cooking. The time required depends on the size of the bird - eg; a large turkey may take up to 48 hours to thaw.

Use of a trivet with a roasting tin will reduce fat splashing and will help to keep the oven interior clean. Alternatively, to help reduce fat splashing, potatoes or other vegetables can be roasted around the meat/poultry.

## Notes:











- When cooking stuffed meat or poultry calculate the cooking time from the total weight of the meat plus the stuffing.
- For joints cooked in foil or covered roasters, and for lidded casseroles, add 5 minutes per 450g (1lb) to the calculated cooking time.
- Smaller joints weighing less than 1.25kg (2½lb) may require 5 minutes per 450g (1lb) extra cooking time.
- Position the oven shelf so that the meat or poultry is in the centre of the oven.
- It is recommended that the appliance is cleaned after open roasting.

<b>Cook in main oven at:</b> <b>160°C - 180°C (fanned)</b> <b>180°C - 200°C (conventional)</b>		<b>Approximate Cooking Time</b> <b>(preheated oven)</b>
<b>Beef</b>	Rare Medium Well done	20 minutes per 450g (1lb), plus 20 minutes 25 minutes per 450g (1lb), plus 25 minutes 30 minutes per 450g (1lb), plus 30 minutes
<b>Lamb</b>	Medium Well Done	25 minutes per 450g (1lb), plus 25 minutes 30 minutes per 450g (1lb), plus 30 minutes
<b>Pork</b>		35 minutes per 450g (1lb), plus 35 minutes
<b>Poultry</b>		20 minutes per 450g (1lb), plus 20 minutes

# USING THE OVEN/GRILL - MULTI-FUNCTION

## Oven & Grill Functions

The chart below details all of the functions which are available. Your oven may not have all of the functions shown here.

Symbol	Function / Feature	Recommended Uses
	Grill, small area	This function cooks food from the top and is ideal for a range of food from toast to steaks. As the whole grill is working you can cook large quantities of food.
	Grill, large area	For grilling steaks,sausages,toast and pieces of fish. The whole area below the grill heating element becomes hot.
	Fanned Grill	The fan allows heat to circulate around the food. Ideal for thinner foods such as bacon, fish and gammon steaks. Foods do not require turning. Use with the oven door closed
	Conventional Grill	This function is ideal for traditional roasting. The meat is placed in the middle of the oven, roast potatoes towards the top.
	bake only	The base heat can be used to provide additional browning for pizzas, pies and quiche. Use this function towards the end of cooking.
	Fanned Oven	The even temperature in the oven makes this function suitable for batch baking, or batch cooking foods.
	Intensive Bake	Suitable for food with a high moisture content, such as quiche, bread and cheese cake. It also eliminates the need for baking pastry blind.
	Defrosting and Cooling	To defrost foods, such as cream cakes/gateaux, use with the oven door closed. For cooling dishes prior to refrigeration, leave the door open.
	Oven Temperature Control	Use to select the oven temperature.
	Lights Only	Use when the oven is switched off and cold to aid cleaning the oven.



# USING THE OVEN/GRILL - MULTI-FUNCTION

## GRILLING IN THE MAIN OVEN

The main oven grill & fanned grill are fixed settings using the inner element only. Make sure that the programmer is set to manual before grilling. When using either grill function, invert the grill pan trivet and preheat for 5minutes.

### Grill, small area



The door must be closed when the grill is used for small area grilling.

- (i) Turn the selector control knob to the small area grill setting.
- (ii) Turn the oven temperature control knob to the full on setting.

### Fanned grill



The door must be closed when the fanned grill is used.  
When opening the door, take care to avoid skin contact with any steam which may escape from the cooking.

- (i) Turn the selector control knob to the fan grill  setting.
- (ii) Turn the oven temperature control knob to the desired temperature setting.

When the fanned grill is selected, only the inner element will come on.

### Grill, large area



The door must be closed when the large area grilling is used.  
When opening the door, take care to avoid skin contact with any steam which may escape from the cooking.

- (i) Turn the selector control knob to the grill, large area  setting.
- (ii) Turn the oven temperature control knob to the desired temperature setting.

When the large area grilling is selected, only the inner element will come on.

**Caution: Accessible parts may be hot when the ovens are used, young children should be kept away.**

The main oven is a multi-function oven, and may be used as a conventional oven or a fanned oven. It may also be used as a grill, or with one of the other oven functions.

### Manual operation

The programmer must be set to manual operation before the main oven or grill functions can be used.

### To turn on the main oven Step 1 - Select the function

Turn the selector control knob in either direction, until the function you require appears in the window.

**Step 2 - Set the main oven control** If you have selected an oven cooking function, then simply turn the main oven temperature control knob to the required temperature - this brings on the neon indicator light, which will stay on until the oven reaches the required temperature. To switch off the main oven, return the control knob to the off position.

# USING THE OVEN/GRILL - MULTI-FUNCTION

---

## Automatic operation

See 'Programmer / Clock' section.

## Using the main oven

*Caution:* Accessible parts may be hot when the appliance is in use - keep children away from the vicinity of the oven.

Never put items directly on the base of the oven or cover the oven base with foil, as this can cause the base element to overheat.

## Manual operation

Set the programmer to manual operation. See 'Programmer / Clock' section. Turn the selector control knob to the symbol for the desired oven function. Turn the main oven temperature control knob to the desired temperature. The red thermostat indicator neon will come on and off until the selected temperature is reached and then go off; it will turn on and off periodically as the thermostat operates to maintain the selected temperature. To switch off the main oven, return the main oven control knob to the off position.

## Automatic operation

See 'Programmer / Clock' section.

## Preheating

Always use the fan oven setting for preheating to save time and electricity. After the oven has been preheated on the fan oven setting, turn the selector control knob to the oven setting you require. The oven must be preheated when cooking frozen or chilled food, and we recommend preheating for yeast mixtures, batters, soufflés and whisked sponges, otherwise

preheating is not necessary as a fan oven warms up quickly. Preheat the oven until the indicator neon switches off for the first time; this will take between 5 - 15 minutes, depending on the temperature selected.

## To help the air circulate freely

- Position the shelves evenly within the oven and maintain a clearance from the oven roof and base.
- If more than one cooking dish or baking tray is to be used on a shelf, leave a gap of at least 25mm between the items themselves and the oven interior.
- Allow enough space between shelves for food that will rise during cooking.
- Do not place items on the oven base as this will prevent air from circulating freely.

## Main oven functions Conventional oven



- (i) Turn the selector control knob to the conventional oven symbol.
- (ii) Turn the main oven control knob to the required temperature.

The temperature you select corresponds to the temperature in the middle of the oven. The top heat comes from the outer element of the grill, and the base heat is under the oven base.

## Base heat only



- (i) Turn the selector control knob to the base heat symbol.
- (ii) Turn the main oven control knob to the required temperature.

# USING THE OVEN/GRILL - MULTI-FUNCTION

---

## Fan oven

(i) Turn the selector control knob to the fan oven symbol.

(ii) Turn the main oven control knob to the required temperature.

The fan oven comes on when the oven is switched on and circulates the air around the oven to give a fairly even temperature throughout the oven.

## Intensive bake

(i) Turn the selector control to the intensive bake symbol.

(ii) Turn the main oven control to the required temperature.

## Defrosting and cooling

(i) Turn the selector control knob to defrost 

(ii) Turn the oven control to the light symbol.

To defrost frozen foods, place food in the centre of the oven and close the door.

To cool foods after cooking prior to refrigeration or freezing, place food in the centre of the oven with the door open.

## Be safe

- Do not defrost stuffed poultry using this method.
- Do not defrost larger joints of meat or poultry over 2kg / 4lb using this method.

- Never place uncooked food which is to be defrosted next to cooked food which is to be cooled, as this can lead to cross contamination.

Please refer to the Cooking Guide for more information on using the Defrost function.

# USING THE CLOCK/PROGRAMMER-ELEC

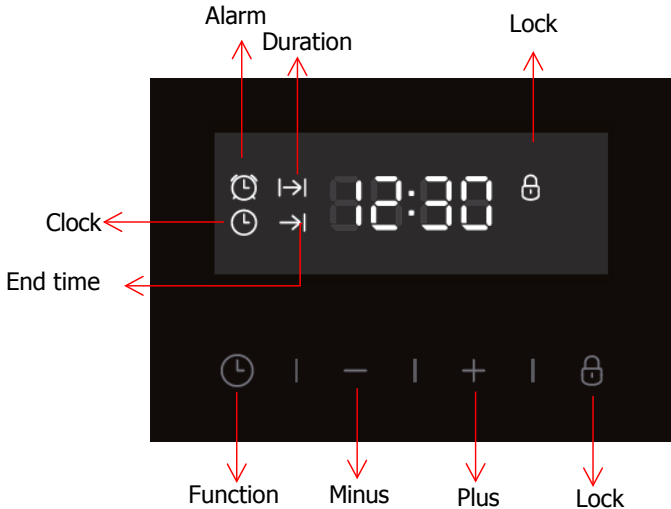

After power on, '0:00' and the clock icon will flash on the screen, press any button to quit.

Button 1: \*clock → alarm setting → duration setting → end time setting → clock setting → \*clock (\*: default)

Button 2: minus(-)

Button 3: plus

Button 4: Lock

## 1. Set alarm

1) Press button 1, alarm icon flashing means alarm function chosen. "0:00" will display. Press button 2 and 3 to set alarm time. Time adjust range is "0:01~23:59". Press once to plus or minus 1, and hold for 3 seconds for quick-adjust. Waiting for 5 seconds to confirm setting, the alarm icon will be display, alarm time will be shown and alarm starts. After the count down, "0:00" will display, buzzing starts 4 times every 5 seconds. Press any button to stop.

2) If there's no operation for 2 minutes, buzzing will stop.

## 2. Duration setting

1) Press button 1, choose 'duration' function, duration icon will flash, "0:00" will display. Press button 2 and 3 to set duration time, adjusting range is "0:01~23:59". Press once to plus or minus 1, hold for 3 seconds for quick-adjust. The flashing will last for 5 seconds, so the settings must be done within this time frame or the time of day will show again. After setting, the duration icon will display, counting down starts. When counting down stops, power will turn off, 'Duration' icon will flash, "0:00" will display, buzzing will start for twice every 5 seconds. Press any button to stop buzzing, and press button 1 to show the time of day.

2) During the cooking duration, press button 1 can check and change the cooking time.

# USING THE CLOCK/PROGRAMMER-ELEC

---

3) After counting down stopping, if there's no operation for 2 minutes, buzzing will stop.

4) If set duration time before end time, end time can only be added, not decreased. (The max time added can be after 23h 59m. When end time is longer than duration time+ current time, end time can be decreased by pressing button 2. It will be decreased until end time equals to duration time+ current time+ 1 minute). If end time is longer than duration time+ current time, power will be off, end time icon will display. When end time equals to duration time+ current time, power will be on again, end time icon will turn off.

## 3、time function

1) Press button 1 to choose time function. Time icon will flash, press button 2 or 3 to set time. The range is 24hrs. Press once to plus or minus 1, hold for 3 seconds for quick-adjust. No operation for 5 seconds, the time of day will show, time icon will turn off.

2) If time setting is changed after setting alarm, duration and end time, the alarm will not be changed, and duration and end time will reset.

## 4、lock function.

Press lock button for 3 seconds any time, the lock function will active, and lock icon will display. Press lock button for 3 seconds again, it will be unlock. The icon turns off.

During the lock condition, press button will cause buzzing, meanwhile the lock icon will flash for 3 seconds.

## 5、Other notification

1) If setting alarm, duration time and end time, alarm time will display, and alarm, duration, end time icons will display.

2) After setting alarm, duration, and end time, Button 1 can be pressed to check and change alarm time, duration time, end time and day time.

3) If duration time is later than alarm time, there will be only buzzing for alarm. If duration is earlier than alarm time, there will be only buzzing for alarm.

# CLEANING

---

## General

- It is important to clean the product regularly as a build up of fat can affect its performance or damage it and may invalidate your guarantee.
- Always switch off your appliance and allow it to cool down before you clean any part of it.
- Do not use undiluted bleaches, products containing chlorides, wire wool or abrasive cleaners on aluminium, stainless steel, or plastic/painted parts as they can damage the appliance. Nylon pads can also be unsuitable.
- Take extra care when cleaning over symbols on fascia panels. Excessive cleaning can lead to the symbols fading.
- If your product is fitted with stainless steel clad stips. You may notice a small white residue on the outer edges, this can be removed with a non abrasive wipe.

## Painted & Plastic parts

- Only use a clean cloth wrung out in hot soapy water.
- Do not use abrasive cleaners, wire or nylon cleaning pads on these parts.

## Stainless steel & Aluminium surfaces

- Only use a clean cloth wrung out in hot soapy water, and dry with a soft cloth.
- Stubborn marks can be removed using a stainless steel cleaner. Supplies can be purchased from the Customer Care Centre.
- Sharp objects can mark the surface of stainless steel, but will become less noticeable with time.
- Wipe any spillage immediately, taking care to avoid burning your hands

- Some foods are corrosive eg; vinegar, fruit juices and especially salt - they can mark or damage the metal if they are left on the surface.
- Baby oil can be used to restore stainless steel finishes - but only use a few drops. Don't use cooking oils as they can contain salts, which will damage the metal.
- Do not use steam cleaners.

## Enamel surfaces & parts

- Clean with warm, soapy water and a clean cloth.
- If larger splashes of fat do not readily disappear, you can use a mild cream cleaner to remove them. More stubborn marks can be removed using a soap filled pad.
- Rinse well and dry with a soft clean towel or cloth.
- Do not use steam cleaners.

## Glass parts

**WARNING:-** Do not use harsh abrasive cleaners or sharp metal scrapers to clean the oven door glass since they can scratch the surface, which may result in shattering of the glass.

- Only use a clean cloth wrung out in hot soapy water, or a specialist glass cleaner.

Rinse away any excess cleaner and dry with a soft cloth.

## Chrome plated parts

- Use a moist soap filled pad, or place in a dishwasher

# CLEANING

## REMOVING OVEN PARTS FOR CLEANING

- To remove the door, open the door to the maximum angle. Then pull the buckle at the door hinge backward.
- Close the door to an angle approximately  $30^\circ$ . Hold the door with one hand on each side. Lift up and slowly pull the door out from the oven.

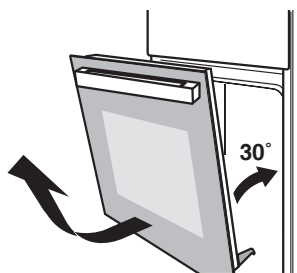
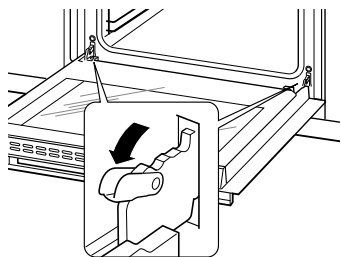

The inner door glass panel can be removed for cleaning but it must be replaced the right way up. If there is any writing on the glass, you must be able to read it clearly when the cavity doors are open.

- Always make sure that the glass is pushed fully into the Stop position.
- To remove the glass panel, open the door wide, push the clips on the left and right sides of door bracket. Then remove the plastic top cover. Hold the glass and slide it out along the door bracket.

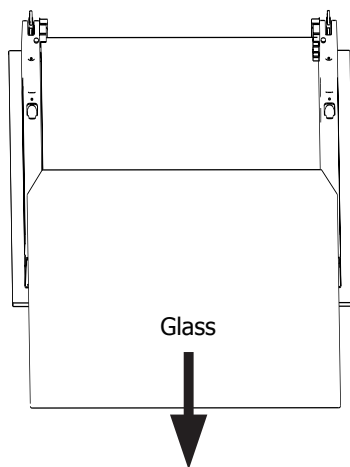
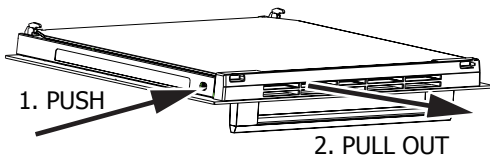

# CLEANING

- **Warning:** Do not operate the appliance without the glass panel correctly fitted.
- For your safety, glass door panels are made of toughened glass. This ensures that, in the unlikely event that a panel breaks, it does so into small fragments to minimise the risk of injury. Please take care when handling, using or cleaning all glass panels, as any damage to the surfaces or edges may result in the glass breaking without warning or apparent cause at a later date. Should any glass panel be damaged, we strongly recommend that it is replaced immediately.

## Shelf Runners

- Shelf runners can be removed to enable you to clean them thoroughly. Make sure they are cool to touch and then grasp the runners and slide out of their hanging holes.

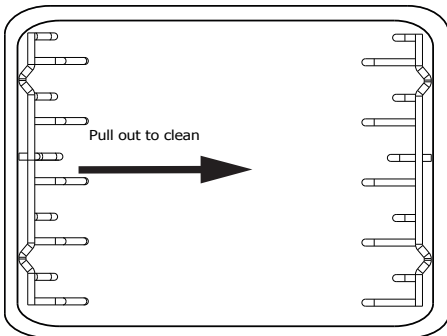

## BULB REPLACEMENT

For replacement, process as follows:

1. Disconnect power from the mains outlet or switch off the circuit breaker of the unit's mains outlet.
2. Unscrew the glass lamp cover by turning it counter-clockwise (note, it may be stiff) and replace the bulb with a new one of the same type.
3. Screw the glass lamp cover back in place.

NOTE: Only use 25-40W/220V-240V , T300°C halogen lamps.

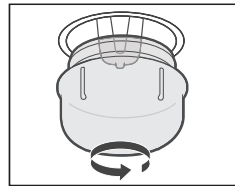



# INSTALLATION-72CM

Do not lift the appliance by the door handle.

Whilst every care is taken to eliminate burrs and raw edges from this product, please take care when handling - we recommend the use of protective gloves during installation.

Please note that the weight of this appliance is approximately 45kg (unpacked). Take care when lifting it into the housing unit - always use an appropriate method of lifting.

Leave the fixing screws in the base tray packaging until you are ready to install it. If this appliance is to be installed near to a corner where the adjacent cabinets run at right angles forward of the appliance, there must be a gap of at least 90 mm between the appliance and the cabinets, to prevent overheating of the cabinets.

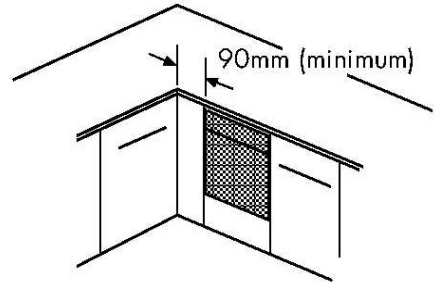

## Housing dimensions

The appliance is designed to fit into a standard 600mm wide housing unit with minimum internal dimensions as shown. 590mm is to the underside of the worktop when the appliance is built under, or to the underside of the panel above, when the appliance is installed into a tall housing unit.

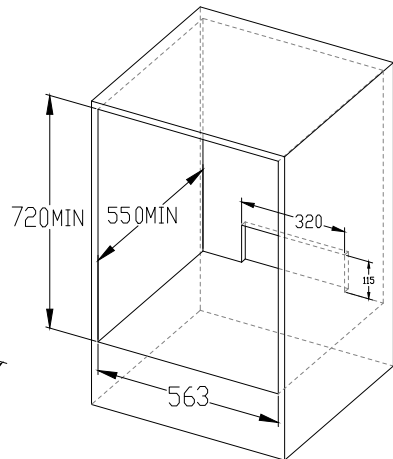
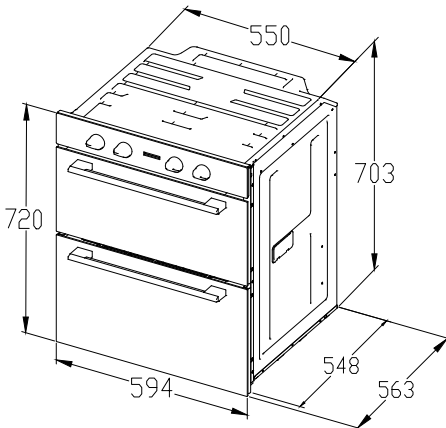

# INSTALLATION - 90CM

## INSTALLATION

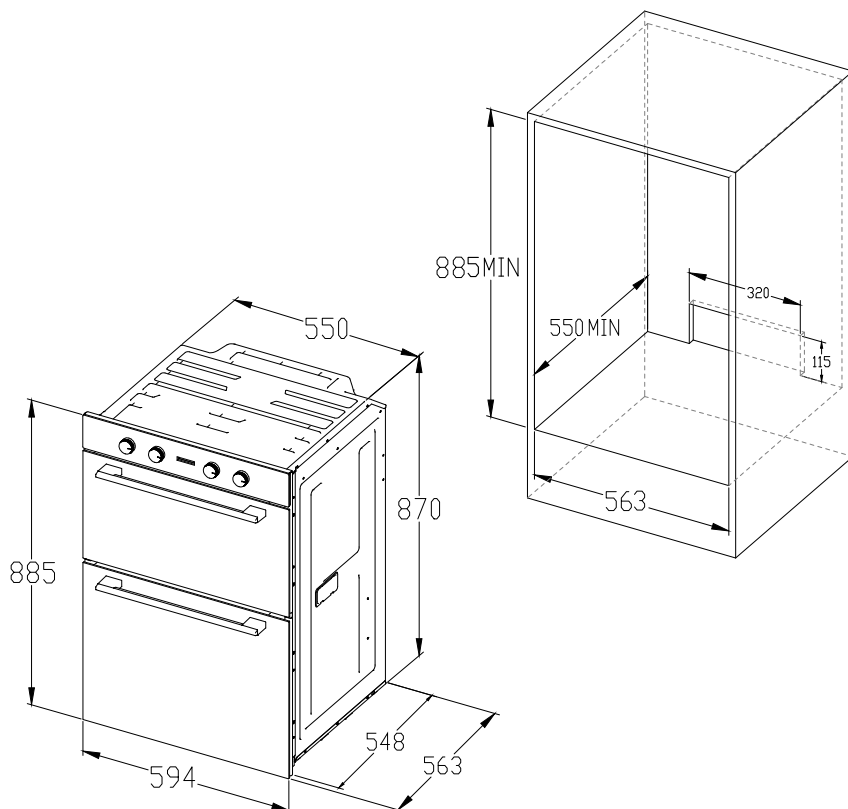

## SECURING THE OVEN TO THE CABINET

1. Fit oven into the cabinet recess.
2. Open the oven door.
3. Secure the oven to the kitchen cabinet with two distance holders " A " which fit the holes in the oven frame and fit the two screws " B " .

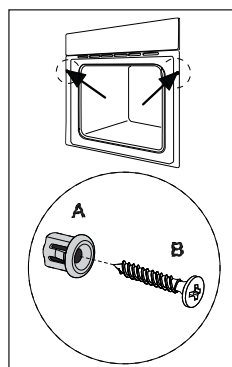

# CONNECTION OF THE OVEN

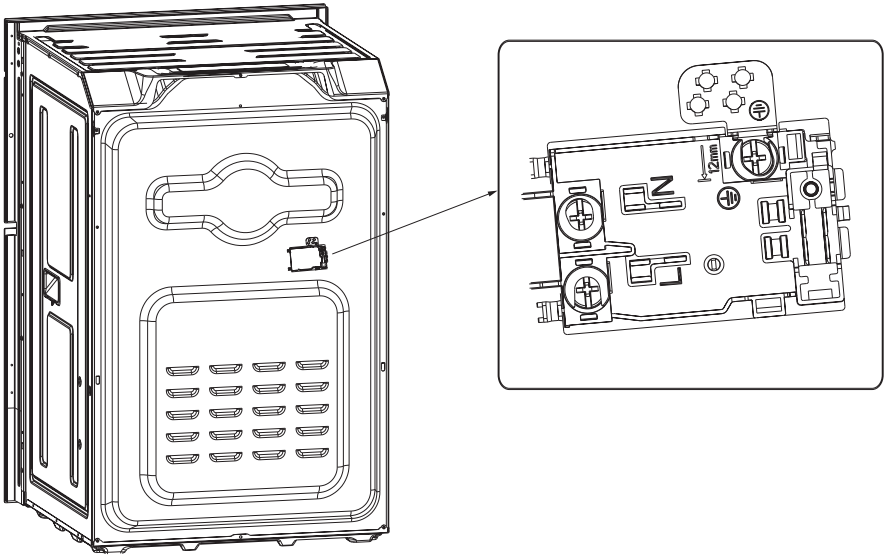

This appliance is marked according to the European directive 2012/19/EU on Waste Electrical and Electronic Equipment (WEEE).

By ensuring this product is disposed correctly, you will help prevent potential negative consequences for the environment and human health, which could otherwise be caused by inappropriate waste handling of this product. The symbol on the product indicates that this product may not be treated as household waste. Instead it shall be handed over to the applicable collection point for the recycling of electrical and electronic equipment. Disposal must be carried out in accordance with local environmental regulations for waste disposal. For more detailed information about treatment, recovery and recycling of this product, please contact your local city office, your household waste disposal service or the shop where you purchased the product.



