

COOKOLOGY

CFSDI20LBK

Microwave User Manual

Microwave Oven

INSTRUCTION MANUAL

Model:CFSDI20LBK

Read these instructions carefully before using your microwave oven, and keep it carefully.

If you follow the instructions, your oven will provide you with many years of good service.

SAVE THESE INSTRUCTIONS CAREFULLY

PRECAUTIONS TO AVOID POSSIBLE EXPOSURE TO EXCESSIVE MICROWAVE ENERGY

(a) Do not attempt to operate this oven with the door open since this can result in harmful exposure to microwave energy. It is important not to break or tamper with the safety interlocks.

(b) Do not place any object between the oven front face and the door or allow soil or cleaner residue to accumulate on sealing surfaces.

(c) **WARNING:** If the door or door seals are damaged, the oven must not be operated until it has been repaired by a competent person.

ADDENDUM

If the apparatus is not maintained in a good state of cleanliness, its surface could be degraded and affect the lifespan of the apparatus and lead to a dangerous situation.

Specifications

Model:	CFSDI20LBK
Rated Voltage:	230V-240V~ 50Hz
Rated Input Power(Microwave):	1200 W-1270 W
Rated Output Power(Microwave):	750 W-800 W
Oven Capacity:	20L
Turntable Diameter:	∅ 255 mm
External Dimensions:	440X350X259mm
Net Weight:	Approx.11.2 kg

IMPORTANT SAFETY INSTRUCTIONS

WARNING

To reduce the risk of fire, electric shock, injury to persons or exposure to excessive microwave oven energy when using your appliance, follow basic precautions, including the following:

1. Read and follow the specific: "PRECAUTIONS TO AVOID POSSIBLE EXPOSURE TO EXCESSIVE MICROWAVE ENERGY".
2. This appliance can be used by children aged from 8 years and above and persons with reduced physical, sensory or mental capabilities or lack of experience and knowledge if they have been given supervision or instruction concerning use of the appliance in a safe way and understand the hazards involved. Children shall not play with the appliance. Cleaning and user maintenance shall not be made by children unless they are older than 8 and supervised. Children less than 8 years of age shall be kept away unless continuously supervised.
3. Keep the appliance and its cord out of reach of children less than 8 years.
4. If the supply cord is damaged, it must be replaced by the manufacturer, its service agent or similarly qualified persons in order to avoid a hazard. (For appliance with type Y attachment)

5. WARNING: Ensure that the appliance is switched off before replacing the lamp to avoid the possibility of electric shock.
6. WARNING: It is hazardous for anyone other than a competent person to carry out any service or repair operation that involves the removal of a cover which gives protection against exposure to microwave energy.
7. WARNING: Liquids and other foods must not be heated in sealed containers since they are liable to explode.
8. When heating food in plastic or paper containers, keep an eye on the oven due to the possibility of ignition.
9. Only use utensils that are suitable for use in microwave ovens.
10. If smoke is emitted, switch off or unplug the appliance and keep the door closed in order to stifle any flames.
11. Microwave heating of beverages can result in delayed eruptive boiling, therefore care must be taken when handling the container.
12. The contents of feeding bottles and baby food jars shall be stirred or shaken and the temperature checked before consumption, in order to avoid burns.
13. Eggs in their shell and whole hard-boiled eggs should not be heated in microwave ovens since they may explode, even after microwave heating has ended.
14. The oven should be cleaned regularly and any food deposits removed.
15. Failure to maintain the oven in a clean condition could lead to deterioration of the surface that could

adversely affect the life of the appliance and possibly result in a hazardous situation.

16. The appliance must not be installed behind a decorative door in order to avoid overheating. (This is not applicable for appliances with decorative door.)

17. Only use the temperature probe recommended for this oven. (for ovens provided with a facility to use a temperature-sensing probe.)

18. The microwave oven shall not be placed in a cabinet unless it has been tested in a cabinet.

19. The microwave oven must be operated with the decorative door open. (for ovens with a decorative door.)

20. This appliance is intended to be used in household and similar applications such as:

- staff kitchen areas in shops, offices and other working environments;

- by clients in hotels, motels and other residential type environments;

- farm houses;

- bed and breakfast type environments.

21. The microwave oven is intended for heating food and beverages. Drying of food or clothing and heating of warming pads, slippers, sponges, damp cloth and similar may lead to risk of injury, ignition or fire.

22. Metallic containers for food and beverages are not allowed during microwave cooking.

23. The appliance shall not be cleaned with a steam cleaner.

24. The appliance is intended to be used freestanding.

25.The rear surface of appliances shall be placed against a wall.

READ CAREFULLY AND KEEP FOR FUTURE REFERENCE

To Reduce the Risk of Injury to Persons Grounding Installation

DANGER

Electric Shock Hazard
Touching some of the internal components can cause serious personal injury or death. Do not disassemble this appliance.

WARNING

Electric Shock Hazard
Improper use of the grounding can result in electric shock. Do not plug into an outlet until appliance is properly installed and grounded.

This appliance must be grounded. In the event of an electrical short circuit, grounding reduces the risk of electric shock by providing an escape wire for the electric current. This appliance is equipped with a cord having a grounding wire with a grounding plug. The plug must be plugged into an outlet that is properly installed and grounded.

Consult a qualified electrician or serviceman if the grounding instructions are not completely understood or if doubt exists as to whether the appliance is properly grounded. If it is necessary to use an extension cord, use only a 3-wire extension cord.

1. A short power-supply cord is provided to reduce the risks resulting from becoming entangled in or tripping over a longer cord.
2. If a long cord set or extension cord is used:
 - 1)The marked electrical rating of the cord set or extension cord should be at least as great as the electrical rating of the appliance.
 - 2)The extension cord must be a grounding-type 3-wire cord.
 - 3)The long cord should be arranged so that it will not drape over the counter top or tabletop where it can be pulled on by children or tripped over unintentionally.

CLEANING

Be sure to unplug the appliance from the power supply.

1. Clean the cavity of the oven after using with a slightly damp cloth.
2. Clean the accessories in the usual way in soapy water.
3. The door frame and seal and neighbouring parts must be cleaned carefully with a damp cloth when they are dirty.
4. Do not use harsh abrasive cleaners or sharp metal scrapers to clean the oven door glass since they can scratch the surface, which may result in shattering of the glass.
5. Cleaning Tip---For easier cleaning of the cavity walls that the food cooked can touch: Place half a lemon in a bowl, add 300ml (1/2 pint) water and heat on 100% microwave power for 10 minutes. Wipe the oven clean using a soft, dry cloth.

UTENSILS

CAUTION

Personal Injury Hazard

It is hazardous for anyone other than a competent person to carry out any service or repair operation that involves the removal of a cover which gives protection against exposure to microwave energy.

See the instructions on "Materials you can use in microwave oven or to be avoided in microwave oven." There may be certain non-metallic utensils that are not safe to use for microwaving. If in doubt, you can test the utensil in question following the procedure below.

Utensil Test:

1. Fill a microwave-safe container with 1 cup of cold water (250ml) along with the utensil in question.
2. Cook on maximum power for 1 minute.
3. Carefully feel the utensil. If the empty utensil is warm, do not use it for microwave cooking.
4. Do not exceed 1 minute cooking time.

Materials you can use in microwave oven

Utensils	Remarks
Browning dish	Follow manufacturer's instructions. The bottom of browning dish must be at least 3/16 inch (5mm) above the turntable. Incorrect usage may cause the turntable to break.
Dinnerware	Microwave-safe only. Follow manufacturer's instructions. Do not use cracked or chipped dishes.
Glass jars	Always remove lid. Use only to heat food until just warm. Most glass jars are not heat resistant and may break.
Glassware	Heat-resistant oven glassware only. Make sure there is no metallic trim. Do not use cracked or chipped dishes.
Oven cooking bags	Follow manufacturer's instructions. Do not close with metal tie. Make slits to allow steam to escape.
Paper plates and cups	Use for short-term cooking/warming only. Do not leave oven unattended while cooking.
Paper towels	Use to cover food for reheating and absorbing fat. Use with supervision for a short-term cooking only.
Parchment paper	Use as a cover to prevent splattering or a wrap for steaming.
Plastic	Microwave-safe only. Follow the manufacturer's instructions. Should be labeled "Microwave Safe". Some plastic containers soften, as the food inside gets hot. "Boiling bags" and tightly closed plastic bags should be slit, pierced or vented as directed by package.
Plastic wrap	Microwave-safe only. Use to cover food during cooking to retain moisture. Do not allow plastic wrap to touch food.
Thermometers	Microwave-safe only (meat and candy thermometers).
Wax paper	Use as a cover to prevent splattering and retain moisture.

Materials to be avoided in microwave oven

Utensils	Remarks
Aluminum tray	May cause arcing. Transfer food into microwave-safe dish.
Food carton with metal handle	May cause arcing. Transfer food into microwave-safe dish.
Metal or metal-trimmed utensils	Metal shields the food from microwave energy. Metal trim may cause arcing.
Metal twist ties	May cause arcing and could cause a fire in the oven.
Paper bags	May cause a fire in the oven.
Plastic foam	Plastic foam may melt or contaminate the liquid inside when exposed to high temperature.
Wood	Wood will dry out when used in the microwave oven and may split or crack.

SETTING UP YOUR OVEN

Names of Oven Parts and Accessories

Remove the oven and all materials from the carton and oven cavity.

Your oven comes with the following accessories:

Glass tray	1
Turntable ring assembly	1
Instruction Manual	1

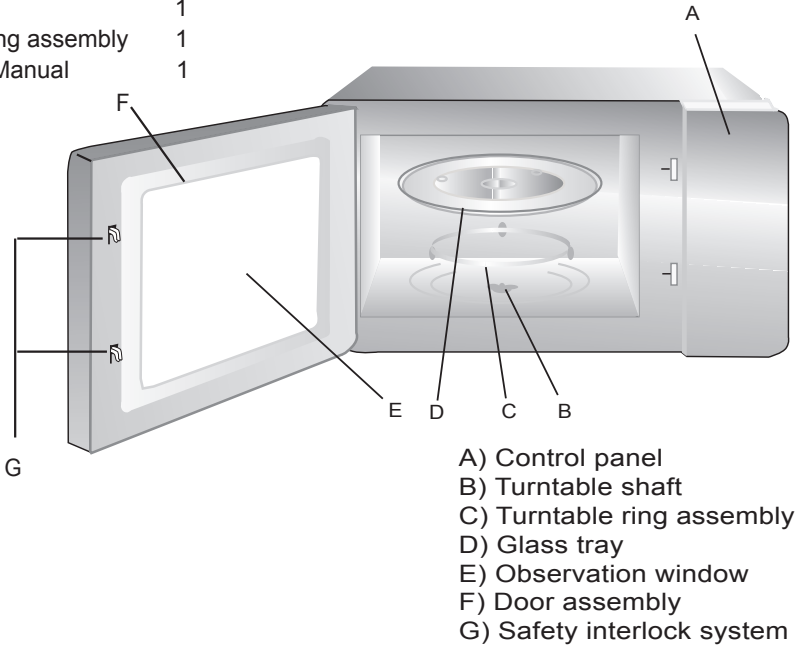

Turntable Installation

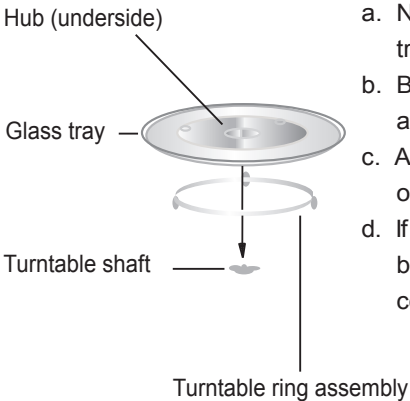

- a. Never place the glass tray upside down. The glass tray should never be restricted.
- b. Both glass tray and turntable ring assembly must always be used during cooking.
- c. All food and containers of food are always placed on the glass tray for cooking.
- d. If glass tray or turntable ring assembly cracks or breaks, contact your nearest authorized service center.

Countertop Installation

Remove all packing material and accessories. Examine the oven for any damage such as dents or broken door. Do not install if oven is damaged.

Cabinet: Remove any protective film found on the microwave oven cabinet surface. Do not remove the light brown Mica cover that is attached to the oven cavity to protect the magnetron.

Installation

1. Select a level surface that provide enough open space for the intake and/or outlet vents.

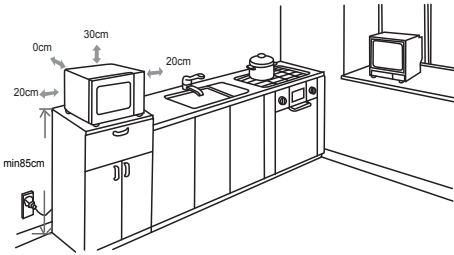

(1) The minimum installation height is 85cm.

(2) The rear surface of appliance shall be placed against a wall.

Leave a minimum clearance of 30cm above the oven, a minimum clearance of 20cm is required between the oven and any adjacent walls.

(3) Do not remove the legs from the bottom of the oven.

(4) Blocking the intake and/or outlet openings can damage the oven.

(5) Place the oven as far away from radios and TV as possible. Operation of microwave oven may cause interference to your radio or TV reception.

2. Plug your oven into a standard household outlet. Be sure the voltage and the frequency is the same as the voltage and the frequency on the rating label.

WARNING: Do not install oven over a range cooktop or other heat-producing appliance. If installed near or over a heat source, the oven could be damaged and the warranty would be void.

The accessible surface may be hot during operation.



CONTROL PANEL

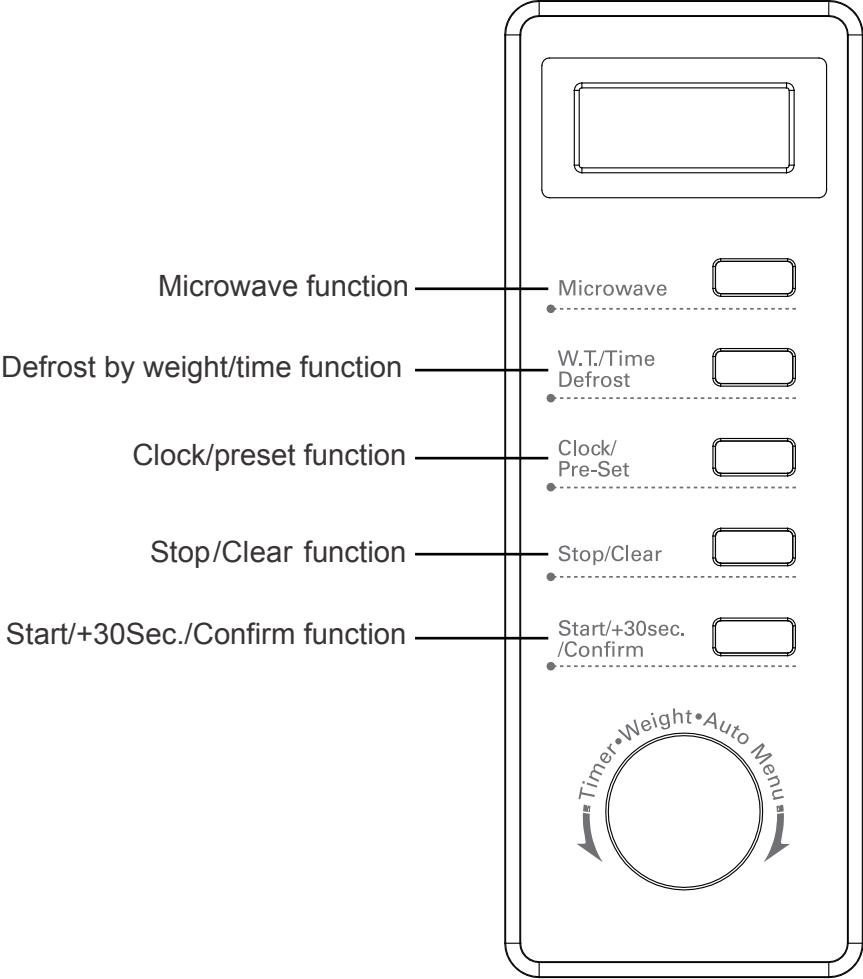



OPERATION INSTRUCTION

This microwave oven uses modern electronic control to adjust cooking parameters to meet your needs better for cooking.

1. Clock Setting



When the microwave oven is electrified, the oven will display "0:00", buzzer will ring once.

- (1) Press " **CLOCK/PRE-SET** ", the hour figure flash;
- (2) Turn "  " to adjust the hour figures, the input time should be within 0--23 .
- (3) Press " **CLOCK/PRE-SET** ", the minute figures will flash.
- (4) Turn "  " to adjust the minute figures, the input time should be within 0--59.
- (5) Press " **CLOCK/PRE-SET** " to finish clock setting. ":" will flash.

Note: (1) If the clock is not set, it would not function when powered.

- (2) During the process of clock setting, if no operation in 1 minute, the oven will go back to the previous status automatically.

2. Microwave Cooking

- (1) Press the " **Microwave** " key once, and "P100" display.
- (2) Press " **Microwave** " repeatedly or turn "  " to select the microwave power "P100", "P80", "P50", "P30", "P10" will display in order.
- (3) Press " **START/+30SEC./CONFIRM** " to confirm.
- (4) Turn "  " to adjust the cooking time. (The time setting should be 0:05- 95:00.)
- (5) Press " **START/+30SEC./CONFIRM** " to start cooking.

NOTE: the step quantities for the adjustment time of the coding switch are as follow:

- 0--1 min : 5 seconds
- 1--5 min : 10 seconds
- 5--10 min : 30 seconds
- 10--30 min : 1 min ute
- 30--95 min : 5 minutes

Microwave Power Chart

Microwave Power	100%	80%	50%	30%	10%
Display	P100	P80	P50	P30	P10

3. Speedy Cooking

- (1) In waiting state, press " **START/+30SEC./CONFIRM** " key to cook with 100% power level for 30 seconds. Each press on the same key can increase 30 seconds. The maximum cooking time is 95 minutes.
- (2) During the microwave and time defrost process, press "**START/+30SEC./CONFIRM** " to increase the cooking time.
- (3) In waiting states, turn "  " left to choose the cooking time directly. After choosing the time, press "**START/+30SEC./CONFIRM** " to start cooking. The microwave power is 100%.
- (4) Under the states of auto menu and weight defrost, cooking time cannot be increased by pressing "**START/+30SEC./CONFIRM** "

4. Defrost By Weight

- (1) Press " **W.T./TIME DEFROST** " once, the screen will display "dEF1".
- (2) Turn "  " to select the food weight. The range of weight is 100-2000g.
- (3) Press " **START/+30SEC./CONFIRM** " key to start defrosting.

5. Defrost By Time



- (1) Press " **W.T./TIME DEFROST** " twice, the screen will display "dEF2".
- (2) Turn "  " to select the cooking time.
- (3) Press " **START/+30SEC./CONFIRM** " key to start defrosting.

6. Multi-Stage Cooking

Two stages can be maximumly set. If one stages is defrosting, it should be put in the first stage. The buzzer will ring once after each stage and the next stage will begin.

Note: Auto menu cannot be set as one of the multi-stage.



Example: if you want to defrost the food for 5 minutes, then to cook with 80% microwave power for 7 minutes. The steps are as following:

- (1) Press " **W.T./TIME DEFROST** " twice, the screen will display "dEF2";
- (2) Turn "  " to adjust the defrost time of 5 minutes;
- (3) Press " **Microwave** " once;
- (4) Turn "  " to choose 80% microwave power till "P80" display;
- (5) Press " **START/+30SEC./CONFIRM** " to confirm;
- (6) Turn "  " to adjust the cooking time of 7 minutes;
- (7) Press " **START/+30SEC./CONFIRM** " to start cooking.



7. Pre-set Function

- (1) Set the clock first. (Consult the instruction of clock setting.)
- (2) Input the cooking program. Two stages can be set at most. Defrosting should not be set in preset function .

Example: if you want to cook with 80% microwave power for 7 minutes.



- a. Press " **Microwave** " once;
- b. Turn "  " to choose 80% microwave power till "P80" display;
- c. Press " **START/+30SEC./CONFIRM** " to confirm;
- d. Turn "  " to adjust the cooking time of 7 minutes;

After the above steps, please do not press " **START/+30SEC./CONFIRM** ". Then do as following:

- (3) Press " **CLOCK/PRE-SET** ". The hour figures flash;
- (4) Turn "  " to adjust the hour figures, the input time should be within 0--23.
- (5) Press " **CLOCK/PRE-SET** ", the minute figures will flash .
- (6) Turn "  " to adjust the minute figures, the input time should be within 0--59.
- (7) Press " **START/+30SEC./CONFIRM** " to finish setting. ":" will light, buzzer will ring twice when the time arrives, then cooking will start automatically.

Note: clock must be set first. Otherwise,pre-set function will not work.

8. Auto Menu

- (1) In waiting states, turn "  " right to choose the menu from "A-1" to "A-8";
- (2) Press " **START/+30SEC./CONFIRM** " to confirm the menu you choose;
- (3) Turn "  " to choose the food weight;
- (4) Press " **START/+30SEC./CONFIRM** " to start cooking;
- (5) After cooking finish, the buzzer sounds five times.

Auto Menu

Menu	Weight	Display	Power
A-1 AUTO REHEAT	200g	200	100%
	400g	400	
	600g	600	
A-2 VEGETABLE	200g	200	100%
	300g	300	
	400g	400	
A-3 FISH	250g	250	80%
	350g	350	
	450g	450	
A-4 MEAT	250g	250	100%
	350g	350	
	450g	450	
A-5 PASTA	50g(with water 450 g)	50	80%
	100g(with water 800 g)	100	
A-6 POTATO	200g	200	100%
	400g	400	
	600g	600	
A-7 PIZZA	200g	200	100%
	400g	400	
A-8 SOUP	200ml	200	80%
	400ml	400	

9. Lock-out Function for Children

Lock: In waiting state, press " **STOP/CLEAR** " for 3 seconds, there will be a long "beep" denoting entering the children-lock state and screen will display " **⏏** ".

Lock quitting: In locked state, press " **STOP/CLEAR** " for 3 seconds, there will be a long "beep" denoting that the lock is released.

10. Inquiring Function

- (1) In cooking states of microwave, press " **Microwave** ", the current power will be displayed for 3 seconds
- (2) In pre-set state, press " **CLOCK/PRE-SET** " to inquire the time for delay start cooking. The pre-set time will flash for 3 seconds, then the oven will turn back to the clock display.
- (3) During cooking state, press " **CLOCK/PRE-SET** " to check the current time. It will be displayed for 3 seconds.

11. Specification

- (1) The buzzer will sound once when turning the knob at the beginning;
- (2) "**START/+30SEC./CONFIRM**" must be pressed to continue cooking if the door is opened during cooking;
- (3) Once the cooking programme has been set , "**START/+30SEC./CONFIRM** " is not pressed in 1 minute. The current time will be displayed. The setting will be cancelled.
- (4) The buzzer sounds once by efficient press, inefficient press will be no response.
- (5) The buzzer will sound five times to remind you when cooking is finished.

Trouble shooting

Normal	
Microwave oven interfering TV reception	Radio and TV reception may be interfered when microwave oven operating. It is similar to the interference of small electrical appliances, like mixer, vacuum cleaner, and electric fan. It is normal.
Dim oven light	In low power microwave cooking, oven light may become dim. It is normal.
Steam accumulating on door, hot air out of vents	In cooking, steam may come out of food. Most will get out from vents. But some may accumulate on cool place like oven door. It is normal.
Oven started accidentally with no food in.	It is forbidden to run the unit without any food inside. It is very dangerous.

Trouble	Possible Cause	Remedy
Oven can not be started.	(1) Power cord not plugged in tightly.	Unplug. Then plug again after 10 seconds.
	(2) Fuse blowing or circuit breaker works.	Replace fuse or reset circuit breaker (repaired by professional personnel of our company)
	(3) Trouble with outlet.	Test outlet with other electrical appliances.
Oven does not heat.	(4) Door not closed well.	Close door well.



According to Waste of Electrical and Electronic Equipment (WEEE) directive, WEEE should be separately collected and treated. If at any time in future you need to dispose of this product please do NOT dispose of this product with household waste. Please send this product to WEEE collecting points where available.

PN:16170000A73461

