

# COOKOLOGY

**Electric hob Instruction manual**  
**SEP600BK/SEP601SS (4 Zones)**

## TABLE OF CONTENTS

Safety instructions .....	3-4
Description of the appliance.....	5
Installation.....	6-7
Operation.....	7-8
Technical data.....	9

# SAFETY INSTRUCTIONS



## Caution!

Do not use the cooker hob until you have read this instruction manual.  
The cooker hob is intended for household use only.

- The appliance becomes hot during operation. Take care not to touch the hot surface.
- Always keep children away from the cooker hob.  
While in operation direct contact with the cooker hob may cause burns!
- Ensure that small items of household equipment, including connection leads, do not touch the hob as the insulation material of this equipment is usually not resistant to high temperatures.
- Do not leave the cooker hob unattended when frying. Oils and fats may catch fire due to overheating or boiling over.
- Do not switch on the hob until a pan has been placed on it.
- Do not put pans weighing over 25kg on the hob.
- Do not use the cooker hob in the event of a technical fault. Any faults must be fixed by an appropriately qualified and authorized person.
- In the event of any incident caused by a technical fault, disconnect the power and report the fault to the service centre to be repaired.
- The rules and provisions contained in this instruction manual should be strictly observed. Do not allow anybody who is not familiar with the contents of this instruction manual to operate the cooker hob.
- The cooker hob should not be cleaned using steam cleaning equipment.
- **IMPORTANT:** The adjacent furniture or housing and all materials used in the installation must be able to withstand a minimum temperature of 85°C above the ambient temperature of the room it is located in, whilst in use.
- Any damage caused by the appliance being installed in contravention of this temperature limit, or by placing adjacent cabinet materials closer than 4mm to the appliance, **will be the liability of the owner.**

- This appliance complies with all current European safety legislation. We do wish to emphasize that this compliance does not remove the fact that the appliance surfaces **will become hot during use and retain heat after operation.**

### **Child Safety**

- **We strongly recommend that babies and young children are prevented from being near to the appliance and not allowed to touch the appliance at any time.**
- **If it is necessary for younger family members to be in the kitchen, please ensure that they are kept under close supervision at all times.**

### **General Safety**

- **Children less than 8 years of age shall be kept away unless continuously supervised.**
- **This appliance can be used by children aged from 8 years and above and persons with reduced physical, sensory or mental capabilities or lack of experience and knowledge if they have been given supervision or instruction concerning use of the appliance in a safe way and understand the hazards involved. Children shall not play with the appliance. Cleaning and user maintenance shall not be made by children without supervision.**
- **NEVER try to extinguish a fire with water, but switch off the appliance and then cover flame e.g. with a lid or a fire blanket.**
- **WARNING: Danger of fire: do not store items on the cooking surfaces.**
- **Means for disconnection must be incorporated in the fixed wiring in accordance with the wiring rules**
- **Do not allow electrical fittings or cables to come into contact with areas on the appliance that get hot.**
- **Do not use the appliance to heat the room it is located in or to dry clothing.**
- **Do not install the appliance next to curtains or soft furnishings.**
- **If the supply cord is damaged, it must be replaced by the manufacturer, its service agent or similarly qualified persons in order to avoid a hazard.**

- the appliance is not intended to be operated by means of an external timer or separate remote-control system.
- This product can be worked but not through outside timer and remote control

## DISPOSAL OF THE APPLIANCE



Old appliances should not simply be disposed of with normal household waste, but should be delivered to a collection and recycling centre for electric and electronic equipment. A symbol shown on the product, the instruction manual or the packaging shows that it is suitable for recycling.

Materials used inside the appliance are recyclable and are labelled with information concerning this. By recycling materials or other parts from used devices you are making a significant contribution to the protection of our environment.

Information on appropriate disposal centres for used devices can be provided by your local authority.

## DESCRIPTION OF THE APPLIANCE

1. front left hot plate ,Ø180mm
2. panel
3. rear left hot plate ,Ø145mm
4. rear right hot plate, Ø180mm
5. operating light red
6. rear left hot plate control knob
7. rear right hot plate control knob
8. front right hot plate control knob
9. front left hot plate control knob
10. front right hot plate, Ø145mm

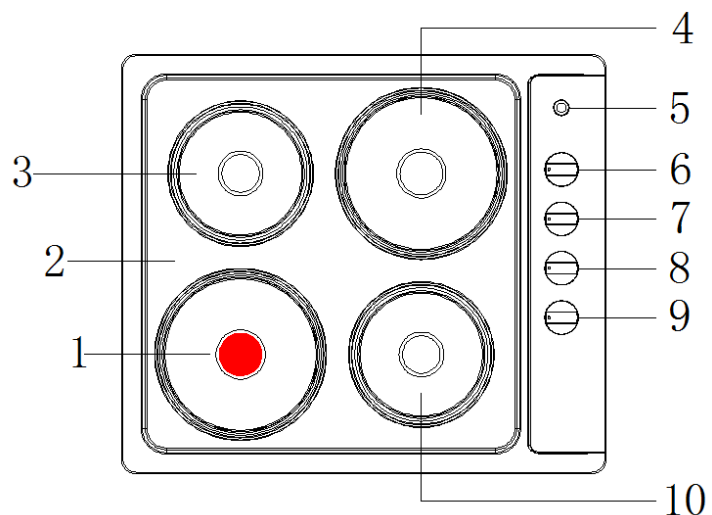

## TECHNICAL DATA

Voltage rating	220-240V~ 50Hz
Power rating	max. 5.5KW

# INSTALLATION

## Installing the cooker hob

- The kitchen area should be dry and aired and equipped with efficient ventilation. When installing the cooker hob, easy access to all control elements should be ensured.
- This is a Y-type design built-in cooker hob, which means that its back wall and one side wall can be placed next to a high piece of furniture or a wall. Coating or veneer used on fitted furniture must be applied with a heat-resistant adhesive (100°C). This prevents surface deformation or detachment the coating.
- Hoods should be installed according to the manufacturer's instructions.

### 1. Assembly of electric hob:

- make an opening with the dimensions given in the diagram for the hob to be mounted on the worktop;
- Check seal for perfect fit and overall cover. Lower the electric hob into place and align correctly.
- Using a standard screwdriver, tighten the tension clamps evenly starting at the centre and moving diagonal, until the built-in rim is tight on the worktop.

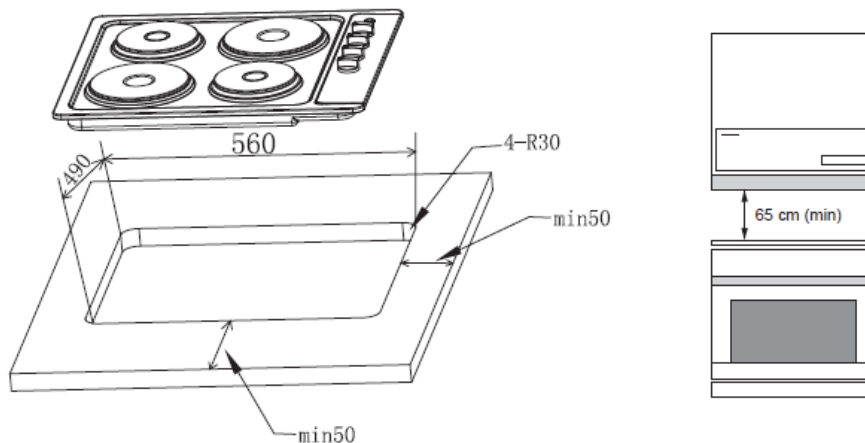

## **Fitting guidelines**

The cooker hob is manufactured to work with 220-240V. The voltage rating of the cooker hob heating elements is 230V. Adapting the cooker hob to operate with one-phase current is possible by appropriate bridging in the connection box according to the connection diagram below. The connection diagram is also found on the cover of the connection box. Remember that the connection wire should match the connection type and the power rating of the cooker hob.

The connection cable must be secured in a strain-relief clamp.

## **Declaration of conformity.**

- The manufacturer declares that the oven is built using certified materials and requires the appliance to be installed in accordance with the standards currently in force. This appliance must be used by a trained person for domestic purposes only.
- \* The RoHS directive stands for “the restriction of the use of certain hazardous substances in electrical and electronic equipment”. This directive bans the placing on the EU market of new electrical and electronic equipment containing more than the agreed levels of lead, cadmium, mercury, hexavalent chromium, polybrominated biphenyl (PBB) and polybrominated diphenyl ether (PBDE) flame retardants.

# OPERATION

## Before first use

- Remove packaging, clean the interior of the hob.
- Switch on the ventilation in the room or open a window.

## Important!

The inside of the oven should only be washed with warm water and a small amount of washing-up liquid.

## How to use the hot plate

The level of heat can be adjusted gradually by turning the appropriate knob to the right or left. Switching on the plate results in a green signal light on the control panel turning on.

An appropriately selected pan saves energy. A pan should have a thick, flat base with a diameter equal to the plate diameter as in that case is transferred most efficiently.

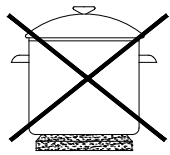

wrong



wrong

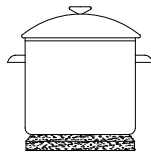

right

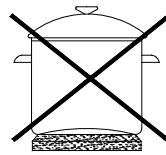

wrong

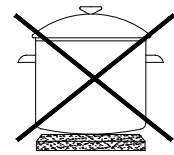

wrong

## Caution!

Ensure the heating plate is clean-a soiled zone does not transfer all of the heat. Protect the plate against corrosion.

Switch off the plate against corrosion.

Do not leave pans with prepared dishes based on fats and oils unattended on the switched-on plate; hot fat can spontaneously catch fire.



## Heat level selection

- 0 Switch off
- 1 MIN. Warming up
- 2 Stewing vegetables, slow cooking
- 3 Cooking soups, larger dishes
- 4 Slow frying
- 5 Grilling meat, fish
- 6 MAX. Fast heating up, fast cooking, frying

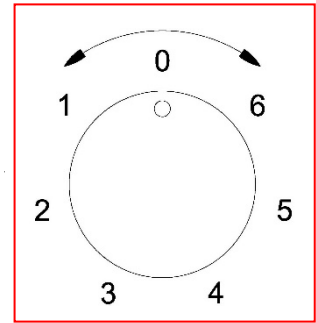
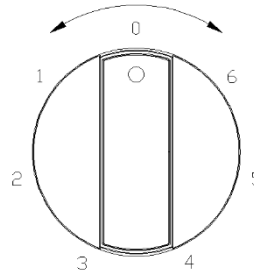

The stainless ornamental rings can be cleaned using washing liquids or gentle liquid scrubbing agents and wiped dry.

The surface of the hotplates should be regularly polished with white mineral oil or silicone oil. Never use animal or vegetable fats like butter, lard, oil etc. for the purpose.

The enamel working plate should be cleaned using warm water with a bit of washing liquid. Larger stains can be removed using gentle scrubbing liquids.



### Caution!

All repairs and regulatory activities should be carried out by the appropriate service centre or by an appropriately authorized fitter.



**IMPORTANT: If your appliance appears not to be operating correctly, Please contact with dealer.**

### DO NOT ATTEMPT TO REPAIR THE APPLIANCE YOURSELF.

Please note that if an engineer is asked to attend whilst the product is under guarantee and finds that the problem is not the result of an appliance fault, then you may be liable for the cost of the call out charge.

The appliance must be accessible for the engineer to perform any necessary repair. If your appliance is installed in such a way that an engineer is concerned that damage will be caused to the appliance or your kitchen, then he will not complete a repair.