

COOKOLOGY

User Instruction

Fridge Freezer

Model:CBIST70302

Please register the warranty for this product on www.Cookology.com

Content

1. Safety Information	Page 1~9
2. Overview	Page 10
3. Reverse Door	Page 11~12
4. Installation	Page 13~16
5. Daily Use	Page 17~22

Please register the warranty for this product on www.Cookology.com

In the interest of your safety and to ensure the correct use, before installing and first using the appliance, read this user manual carefully, including its hints and warnings. To avoid unnecessary mistakes and accidents, it is important to ensure that all people using the appliance are thoroughly familiar with its operation and safety features. Save these instructions and make sure that they remain with the appliance if it is moved or sold, so that everyone using it through its life will be properly informed on appliance use and safety.

For the safety of life and property keep the precautions of these user's instructions as the manufacturer is not responsible for damages caused by omission.

Children and vulnerable people safety

- This appliance can be used by children aged from 8 years and above and persons with reduced physical, sensory or mental capabilities or lack of experience and knowledge if they have been given supervision or instruction concerning use of the appliance in a safe way and understand the hazards involved.
- Children aged from 3 to 8 years are allowed to load and unload this appliance.
- Children should be supervised to ensure that they do not play with the appliance.
- Cleaning and user maintenance shall not be made by children unless they are aged from 8 years and above and supervised.
- Keep all packaging well away from children. There is risk of suffocation.

- If you are discarding the appliance pull the plug out of the socket, cut the connection cable (as close to the appliance as you can) and remove the door to prevent playing children to suffer electric shock or to close themselves into it.
- If this appliance featuring magnetic door seals is to replace an older appliance having a spring lock (latch) on the door or lid, be sure to make that spring lock unusable before you discard the old appliance. This will prevent it from becoming a death trap for a child.

General safety

 **WARNING!** Keep ventilation openings, in the appliance enclosure or in the built-in structure, clear of obstruction.

 **WARNING!** Do not use mechanical devices or other means to accelerate the defrosting more than those recommended by the manufacturer.

 **WARNING!** Do not damage the refrigerant circuit.

 **WARNING!** Do not use other electrical appliances (such as ice cream makers) inside of refrigerating appliances, unless they are approved for this purpose by the manufacture.

 **WARNING!** Do not touch the light bulb if it has been on for a long period of time because it could be very hot.¹⁾

1) If there is a light in the compartment.

 **WARNING!** When positioning the appliance, ensure the supply cord is not trapped or damaged.

 **WARNING!** Do not locate multiple portable socket-outlets or portable power suppliers at the rear of the appliance.

- Do not store explosive substances such as aerosol cans with a flammable propellant in this appliance.
- The refrigerant isobutane (R-600a) is contained within the refrigerant circuit of the appliance, a natural gas with a high level of environmental compatibility, which is nevertheless flammable.
- During transportation and installation of the appliance, be certain that none of the components of the refrigerant circuit become damaged.
 - avoid open flames and sources of ignition
 - thoroughly ventilate the room in which the appliance is situated
- It is dangerous to alter the specifications or modify this product in any way. Any damage to the cord may cause a short circuit, fire and/or electric shock.
- This appliance is intended to be used in household and similar applications such as
 - staff kitchen areas in shops, offices and other working environments;
 - farm houses and by clients in hotels, motels and other residential type environments;
 - bed and breakfast type environments;
 - catering and similar non-retail applications.

 **WARNING!** Any electrical components (plug, power cord, compressor and etc.) must be replaced by a certified service agent or service personnel.

 **WARNING!** The light bulb supplied with this appliance is a “special use lamp bulb” usable only with the appliance supplied. This “special use lamp” is not usable for domestic lighting.¹⁾

- Power cord must not be lengthened.
- Make sure that the power plug is not squashed or damaged by the back of the appliance. A squashed or damaged power plug may overheat and cause a fire.
- Make sure that you can come to the mains plug of the appliance.
- Do not pull the mains cable.
- If the power plug socket is loose, do not insert the power plug. There is a risk of electric shock or fire.
- You must not operate the appliance without the lamp.
- This appliance is heavy. Care should be taken when moving it.
- Do not remove nor touch items from the freezer compartment if your hands are damp/wet, as this could cause skin abrasions or frost/freezer burns.
- Avoid prolonged exposure of the appliance to direct sunlight.

Daily use







- Do not put hot on the plastic parts in the appliance.
- Do not place food products directly against the rear wall.

1) If there is a light in the compartment.





- Frozen food must not be re-frozen once it has been thawed out. ¹⁾
- Store pre-packed frozen food in accordance with the frozen food manufacturer's instructions. ¹⁾
- Appliance's manufacturer's storage instructions must be strictly adhered to. Refer to relevant instructions.
- Do not place carbonated or fizzy drinks in the freezer compartment as it creates pressure on the container, which may cause it to explode, resulting in damage to the appliance. ¹⁾
- Ice lollies can cause frost burns if consumed straight from the appliance. ¹⁾
- To avoid contamination of food, please respect the following instructions
- Opening the door for long periods can cause a significant increase of the temperature in the compartments of the appliance.
- Clean regularly surfaces that can come in contact with food and accessible drainage
- Clean water tanks if they have not been used for 48h; flush the water system connected to a water supply if water has not been drawn for 5 days.
- Store raw meat and fish in suitable containers in the refrigerator, so that it is not in contact with or drip onto other food.
- Two-star frozen-food compartments (if they are presented in the appliance) are suitable for storing pre-frozen food, storing or making ice-cream and making ice cubes.

¹⁾ If there is a freezer compartment.

²⁾ If there is a fresh-food storage compartment.





- One-, two- and three -star compartments (if  are presented in the ) are not  for the freezing of fresh food.
- If the  is left empty for long periods, switch off, defrost, clean, dry and leave the  open to prevent mould developing within .

Care and cleaning

- Before maintenance, switch off the appliance  disconnect the  from the mains .
- Do not clean the appliance with metal objects.
- Do not use sharp objects to remove frost from . Use a plastic scraper.¹⁾
- Regularly examine the drain in the refrigerator  defrosted water. If necessary, clean the drain. If the drain is blocked, water will collect in the bottom of the appliance.²⁾

Installation

Important! For electrical connection carefully follow the instructions given in specific paragraphs.

- Unpack the  and check if there are damages on it. Do not connect the  if it is . Report possible damages  immediately to the place you bought it. In that case retain packing.

1) If there is a freezer compartment.

2) If there is a fresh-food storage compartment.

- It is advisable to wait at least four hours before connecting the appliance to allow the oil to flow back in the compressor.
- Adequate air circulation should be around the appliance, lacking this leads to overheating. To achieve sufficient ventilation follow the instructions relevant to installation.
- Wherever possible the spacers of the product should be against a wall to avoid touching (or catching) warm parts (compressor, condenser) to prevent possible burn.
- The appliance must not be located close to radiators or cookers.
- Make sure that the mains plug is accessible after the installation of the appliance.

Service



- Any electrical work required to do the servicing of the appliance should be carried out by a qualified electrician or competent person.
- This product must be serviced by an authorized Service Center, and only genuine spare parts be used.

Energy saving

- Don't put hot food in the appliance;
- Don't pack food close together as this prevents circulating;
- Make sure food don't touch the back of the compartment(s);

- If electricity goes off, don't open the door(s);
- Don't open the door(s) frequently;
- Don't keep the door(s) open for too long time;
- Don't set the thermostat on exceeding cold temperatures;
- All accessories, such as drawers, shelves balconies, should be kept there for lower energy consumption.

Environment Protection

 This appliance does not contain gases which could damage the ozone layer, in either its refrigerant circuit or insulation materials. The appliance shall not be discarded together with the urban refuse and rubbish. The insulation foam contains flammable gases: the appliance shall be disposed according to the appliance regulations to obtain from your local authorities. Avoid damaging the cooling unit, especially the heat exchanger. The materials used on this appliance marked by the symbol  are recyclable.

 The symbol on the product or on its packaging indicates that this product may not be treated as household waste. Instead it should be taken to the appropriate collection point for the recycling of electrical and electronic equipment. By ensuring this product is disposed of correctly, you will help prevent potential negative consequences for the environment and human health,

which could otherwise be caused by inappropriate waste handling of this product. For more detailed information about recycling of this product, please contact your local council, your household waste disposal service or the shop where you purchased the product.





Packaging materials

The materials with the symbol are recyclable. Dispose the packaging in a suitable collection containers to recycle it.

Disposal of the appliance

1. Disconnect the mains plug from the mains socket.
2. Cut off the mains cable and discard it.



WARNING! During using, service and disposal the appliance, please pay attention to symbol  as left side, which is located on rear of appliance (rear panel or compressor   ).

It's risk of fire warning symbol. There are flammable materials in refrigerant pipes and compressor. 

Please be far away fire source during using, service and disposal.

Overview

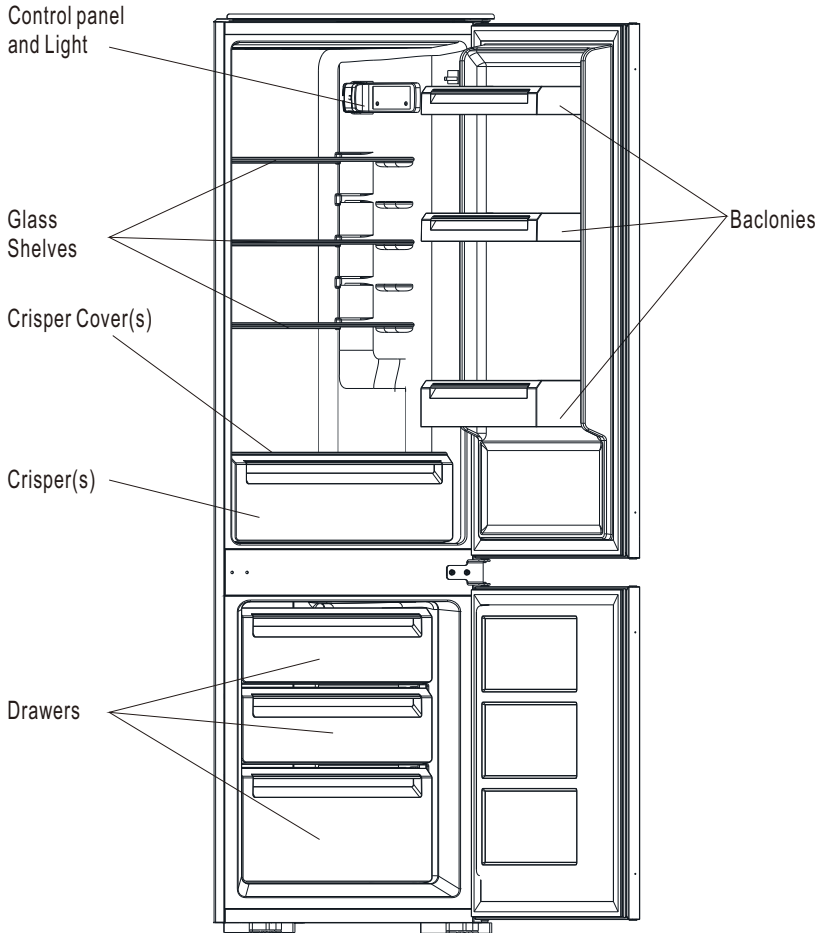

Note: This drawing is only a guide, for more detailed information please refer to actual appliance.

Reverse Door

Tool required: Philips screwdriver, Flat bladed screwdriver, Hexagonal spanner.

- Ensure the unit is unplugged and empty.
- To take the door off, it is necessary to tilt the unit backwards. You should rest the unit on something solid so that it will not slip during the door reversing process.
- All parts removed must be saved to do the reinstallation of the door.
- Do not lay the unit flat as this may damage the coolant system.
- It's better that 2 people handle the unit during assembly.

1. Unscrew the top hinge. Then lift the upper door and place it on a padded surface to avoid scratching.

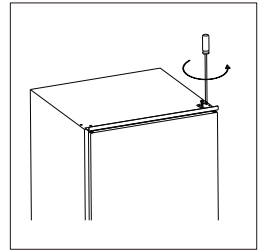

2. Unscrew middle hinge and then lift bottom door and place it on a padded surface to avoid scratching.

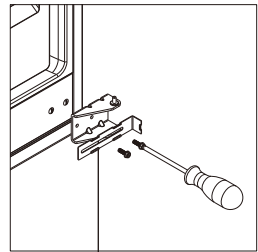

3. Remove bottom hinge pin from right to left.

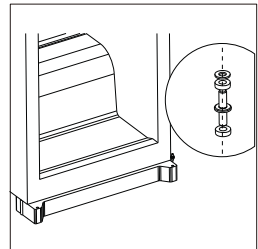

4. Move middle bracket from left to right. Then re-fit bottom door.

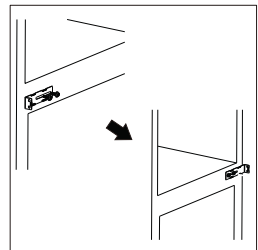

Reverse Door

5. Detach the Fridge and the Freezer door gaskets and then attach them after rotating.

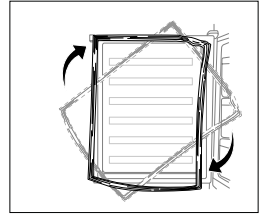

6. Re-fit middle hinge to left side. Ensure bottom door is aligned horizontally and vertically, so that the seals are closed on all sides before finally tightening the middle hinge.

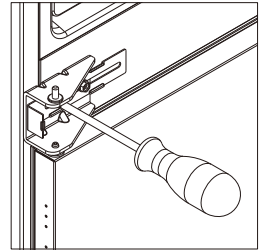

7. Unscrew top hinge pin from the hinge. Then turn the hinge over and screw hinge pin.

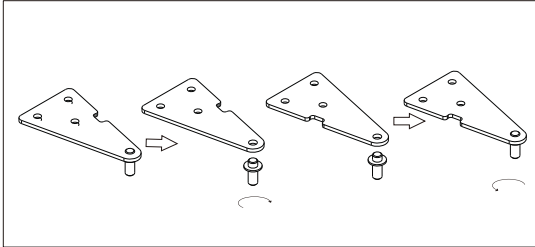

8. Re-fit upper door and then upper hinge on left side. Ensure upper door is aligned horizontally and vertically, so that the seals are closed on all sides before finally tightening the upper hinge. If necessary, a spanner to tighten the hinge.

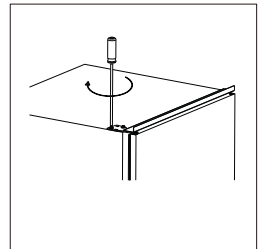

Installation

Kits for installation



Guide x 4



Guide Cover x 4

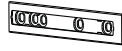

Slider x 4



Slider Cover x 4



Short Screw x 27



Long Screw x 2



Rubber Seal x 1

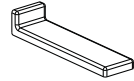

Middle Bracket Cover x 2

Install the appliance

1. Ensure the size of cabinet and ventilation are enough.

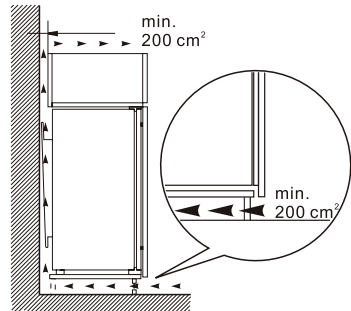
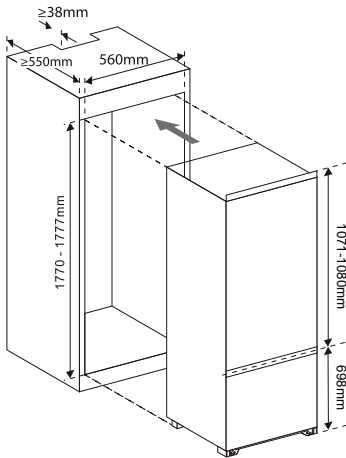

Installation

2. Slowly and carefully push the appliance into the cabinet. Ensure the opening side is as close to the cabinet wall as possible.

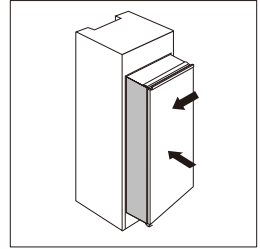

3. Screw a guide to holes in the side of appliance door by short screw. Insert the slider into the guide, then fully open and close appliance door and wooden door to check whether wooden door can close totally and smoothly.

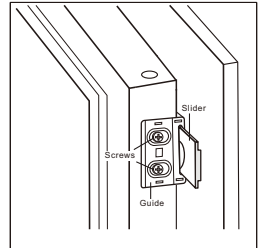

4. Open appliance door and wooden door together and mark the position of slider when the slider can function well at all angle during door closes or opens. Take slider out of guide and fix slider with wooden door by two short screws. Then fix slider cover onto the slider.

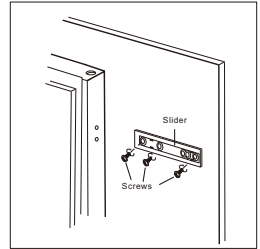

5. Unscrew the guide from appliance door.

6. Repeat step 2 to 5 to fix other three sliders and covers.

7. Fit four guides with sliders and fix them with short screws. Then fix guide covers with guides.

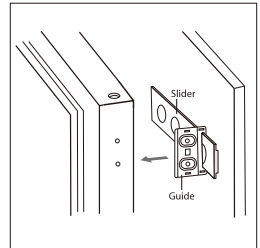

Installation

8. Double check the door can close and open smoothly and appliance is sealed well. If not, slightly adjust the unit. Then fix bottom bracket with wooden cabinet by 2 long screws.

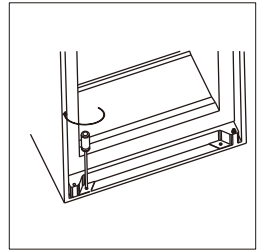

9. Fix top bracket with wooden cabinet by short screws.

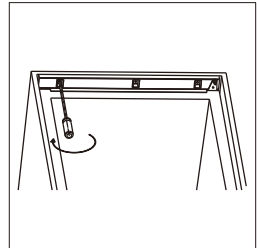

10. Attached rubber seal to the gap between unit and wooden cabinet at door open side.

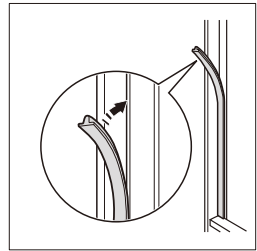

11. Screw two middle brackets with wooden cabinet by short screws. Then fit middle bracket covers with brackets at two sides.

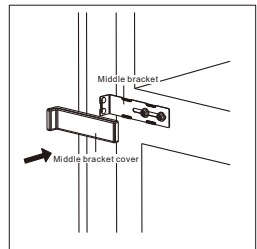
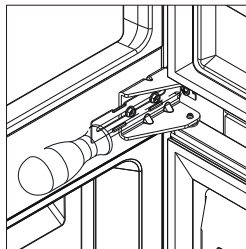

Installation

Positioning

Install this appliance at a location where the ambient temperature corresponds to the climate class indicated on the rating plate of the appliance:

for refrigerating appliances with climate class:

- extended temperature: this refrigerating appliance is intended to be used at ambient temperatures ranging from 10 °C to 32 °C; (SN)
- temperate: this refrigerating appliance is intended to be used at ambient temperatures ranging from 16 °C to 32 °C; (N)
- subtropical: this refrigerating appliance is intended to be used at ambient temperatures ranging from 16 °C to 38 °C; (ST)
- tropical: this refrigerating appliance is intended to be used at ambient temperatures ranging from 16 °C to 43 °C; (T)

Location

The appliance should be installed well away from sources of heat such as radiators, boilers, direct sunlight etc.



Warning! It must be possible to disconnect the appliance from the mains power supply; the plug must therefore be easily accessible after installation.

Electrical connection

Before plugging in, ensure that the voltage and frequency shown on the rating plate correspond to your domestic power supply. The appliance must be earthed. The power supply cable plug is provided with a contact for this purpose. If the domestic power supply socket is not earthed, connect the appliance to a separate earth in compliance with current regulations, consulting a qualified electrician.

The manufacturer declines all responsibility if the above safety precautions are not observed. This appliance complies with the E. E. C. Directives.

Daily Use

First use

Cleaning the interior

Before using the appliance for the first time, wash the interior and all internal accessories with lukewarm water and some neutral soap so as to remove the typical smell of a brand new product, then dry thoroughly.

Important! Do not use detergents or abrasive powders, as these will damage the finish.

Control Panel

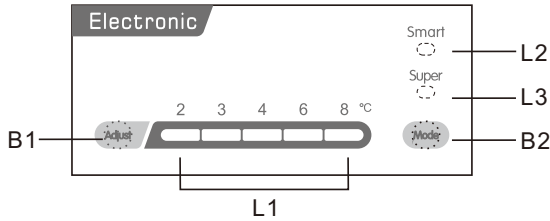

Buttons

B1 – Press to adjust temperature of fridge compartment in cycle of 2,3,4,6,to 8.

B2 – Press to select mode from SMART, SUPER and user's setting.

Lights

L1 – show the setting temperature of fridge compartment.

L2 – light on once SMART mode is selected.

L3 – light on once SUPER mode is selected.

Operation

Temperature Setting

1. Press Mode button to select user's setting.

2. Press Adjust button to adjust the setting temperature of fridge. The temperature of freezer is automatically controlled at around -18°C.

Smart Mode

Press Mode button to select SMART mode.

The appliance will runs automatically according to ambient temperature around the appliance.

Super Mode

Press Mode button to select SUPER mode.

The appliance will runs to make freezer compartment coldest. After 54 hours, the original temperature set will be automatically restored.

Turn off the appliance

Press and hold Adjust button for 5 seconds, the appliance will turn off. Press again to turn on the appliance.

Door open alarm

The alarm will sound when door is left open for 90 seconds and it will not stop until the door is closed.

Daily Use

Temperature setting recommendation

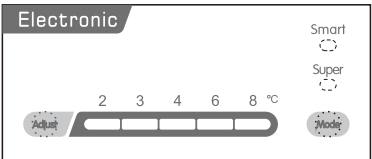
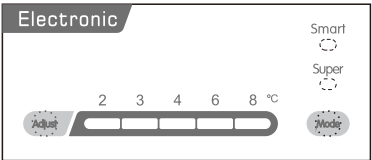
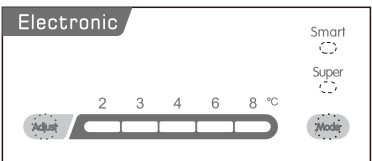
Temperature Setting Recommendation		
Environment Temperature	Freezer compartment	Fridge compartment
Summer	/	 <p>Set on 2~4</p>
Normal	/	 <p>Set on 4</p>
Winter	/	 <p>Set on 4~6</p>

Recommended storage time

- Under Recommended setting, the best storage time of fridge is no more than 3 days.
- Under Recommended setting, the best storage time of freezer is no more than 1 month.
- The best storage time may reduce under other settings.

Daily Use

Position different food in different compartments according to be below table

Refrigerator compartments	Type of food
Door or balconies of fridge compartment	<ul style="list-style-type: none">• Foods with natural preservatives, such as jams,juices, drinks, condiments.• Do not store perishable foods.
Crisper drawer (salad drawer)	<ul style="list-style-type: none">• Fruits, herbs and vegetables should be placed separately in the crisper bin.• Do not store bananas, onions, potatoes, garlic in the refrigerator.
Fridge shelf – middle	<ul style="list-style-type: none">• Dairy products, eggs
Fridge shelf – top	<ul style="list-style-type: none">• Foods that do not need cooking, such as ready-to-eat foods, deli meats, leftovers.
Freezer drawer(s)/shelf	<ul style="list-style-type: none">• Foods for long-term storage.• Bottom drawer/shelf for raw meat, poultry, fish.• Middle drawer/shelf for frozen vegetables, chips.• Top drawer/shelf for ice cream, frozen fruit, frozen baked goods.

Freezing fresh food

- The freezer compartment is suitable for freezing fresh food and storing frozen and deep-frozen food for a long time.
- Place the fresh food to be frozen in the freezer compartment.
- The maximum amount of food that can be frozen in 24 hours is specified on the rating plate.
- The freezing process lasts 24 hours: during this period do not add other food to be frozen.

Storing frozen food

When first starting-up or after a period out of use, before putting the product in the compartment let the appliance run at least 2 hours on the higher settings.

Important! In the event of accidental defrosting, for example the power has been off for longer than the value shown in the technical characteristics chart under "rising time", the defrosted food must be consumed quickly or cooked immediately and then re-frozen (after cooked).

Thawing

Deep-frozen or frozen food, prior to be used, can be thawed in the fridge compartment or at room temperature, depending on the time available for this operation.

Small pieces may even be cooked still frozen, directly from the freezer. In this case, cooking will take longer.

Daily Use

Ice-cube

This appliance may be equipped with one or more ice-cube to produce ice.

Accessories

Movable shelves

The walls of the refrigerator are equipped with a series of runners so that the shelves can be positioned as desired.

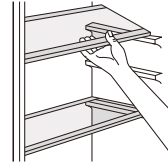

Positioning the door balconies

To permit storage of food packages of various sizes, the door balconies can be removed. To make these adjustments proceed as follows: gradually pull the balcony in the direction of the arrows until it comes free.



Helpful hints and tips

To help you make the most of the freezing process, here are some important hints:

- the maximum quantity of food which can be frozen in 24 hrs. is shown on the rating plate;
- the freezing process takes 24 hours. No further food to be frozen should be added during this period;
- only freeze top quality, fresh and thoroughly cleaned, foodstuffs;
- prepare food in small portions to enable it to be rapidly and completely frozen and to make it possible subsequently to thaw only the quantity required;
- wrap up the food in aluminium foil or polythene and make sure that the packages are airtight;
- do not allow fresh, unfrozen food to touch food which is already frozen, thus avoiding a rise in temperature of the latter;
- lean foods store better and longer than fatty ones; salt reduces the storage life of food;
- water ices, if consumed immediately after removal from the freezer compartment, can possibly cause the skin to be freeze burnt;
- it is advisable to show the freezing in date on each individual pack to enable you removal from the freezer compartment, can possibly cause the skin to be freeze burnt;
- it is advisable to show the freezing in date on each individual pack to enable you to keep tab of the storage time.

Hints for storage of frozen food

To obtain the best performance from this appliance, you should:

- make sure that the commercially frozen foodstuffs were adequately stored by the retailer;
- be sure that frozen foodstuffs are transferred from the food store to the freezer in the shortest possible time;
- not open the door frequently or leave it open longer than absolutely necessary.
- once defrosted, food deteriorates rapidly and cannot be re-frozen;
- do not exceed the storage period indicated by the food manufacture.

Hints for fresh food refrigeration

To obtain the best performance:

- Do not store warm food or evaporating liquids in the refrigerator
- Do cover or wrap the food, particularly if it has a strong flavour
- Make (all types): wrap in polythene bags and place on the glass shelves above the vegetable drawer.
- For safety, store in this way only one or two days at the most.
- Cooked foods, cold dishes, etc...: these should be covered and may be placed on any shelf.
- Fruit and vegetables: these should be thoroughly cleaned and placed in the special drawer(s) provided.
- butter and cheese: these should be placed in special airtight containers or wrapped in aluminum foil or

Daily Use

polythene bags to exclude as much air as possible.

- Milk bottle: these should have a cap and should be stored in the balconies on the door.
- Bananas, potatoes, onions and garlic, if not packed, must not be kept in the fridge.

Cleaning

For hygienic reasons the appliance interior, including interior accessories, should be cleaned regularly.

Caution! The appliance may not be connected to the mains during cleaning. Danger of electrical shock! Before cleaning switch the appliance off and remove the plug from the mains, or switch off or turn out the circuit breaker or fuse. Never clean the appliance with a steam cleaner. Moisture could accumulate in electrical components, danger of electrical shock! Hot vapors can lead to the damage of plastic parts. The appliance must be dry before it is placed back into service.

Important! Ethereal oils and organic solvents can attack plastic parts, e.g. lemon juice or the juice from orange peel, butyric acid, cleanser that contain acetic acid.

- Do not allow such substances to come into contact the appliance parts.
- Do not use any abrasive cleaners
- Remove the food from the freezer. Store them in a cool place, well covered.
- Switch the appliance off and remove the plug from the mains, or switch off or turn out the circuit breaker of fuse.
- Clean the appliance and the interior accessories with a cloth and lukewarm water. After cleaning wipe with fresh water and rub dry.
- After everything is dry place appliance back into service.

Clean drain hole

To avoid defrost water overflowing into the fridge, periodically clean the drain hole at back of fridge compartment. Use a cleaner to clean the hole as showed in right picture.

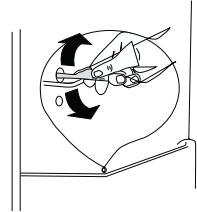

Replace the lamp

This product contains a light source of energy efficiency class 'G'.

Light source in this product is replaceable only by qualified engineers.

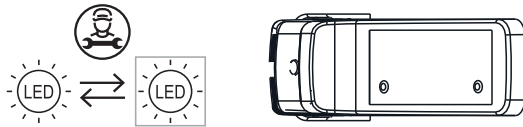

Defrosting of the freezer

The freezer compartment, however, will become progressively covered with frost. This should be removed. Never use sharp metal tools to scrape off frost from the evaporator as you could damage it.

However, when the ice becomes very thick on the inner liner, complete defrosting should be carried out as follows:

- pull out the plug from the socket;
- remove all stored food, wrap it in several layers of newspaper and put it in a cool place;
- keep the door open, and placing a basin underneath of the appliance to collect the defrost water;
- when defrosting is completed, dry the interior thoroughly
- replace the plug in the power socket to run the appliance again.

Product Information

The model information can be retrieved using the QR-Code reported in the energy label. The model information is also available at <https://eprel.ec.europa.eu> by searching the model identifier, which can be found on the rating plate located at the external rear panel of the appliance.

Daily Use

Troubleshooting



Caution! Before troubleshooting, disconnect the power supply. Only a qualified electrician of competent person must do the troubleshooting that is not in this manual.

Important! There are some sounds during normal use (compressor, refrigerant circulation).

Problem	Possible cause	Solution
Appliance does not work	Appliance is turned off.	Press "Adjust" button for 5 seconds to turn on the appliance.
	Mains plug is not plugged in or is loose	Insert mains plug.
	Fuse has blown or is defective	Check fuse, replace if necessary.
	Socket is defective	Mains malfunctions are to be corrected by an electrician.
The food is too warm.	Temperature is not properly adjusted.	Please look in the initial Temperature Setting section.
	Door was open for an extended period.	Open the door only as long as necessary.
	A large quantity of warm food was placed in the appliance within the last 24 hours.	Turn the temperature regulation to a colder setting temporarily.
	The appliance is near a heat source.	Please look in the installation location section.
Appliance cools too much	Temperature is set too cold.	Turn the temperature regulation knob to a warmer setting temporarily.
Unusual noises	Appliance is not level.	Adjust the wood cabinet if it's not level.
	The appliance is touching the wall or other objects.	Move the appliance slightly.
	A component, e.g. a pipe, on the rear of the appliance is touching another part of the appliance or the wall.	If necessary, carefully bend the component out of the way.
Water on the floor	Water drain hole is blocked.	See the Cleaning section.

If the malfunction shows again, contact the Service Center.

Please register the warranty for this product on www.Cookology.com

The Wright Buy Ltd.

Unit 2 Piperell Way, Haverhill, Suffolk, CB9 8QW, United Kingdom

Cookology Limited,

Ground floor, 71 Lower Baggot Street, Dublin 2, D02 P593