

# COOKOLOGY

OUR PRODUCTS, YOUR HOME.

models

**CWM6KG1000**

**CWM7KG1200**

Please register the warranty for this product on [www.Cookology.com](http://www.Cookology.com)

**COOKOLOGY T/A THE WRIGHT BUY LTD**  
**7 Meadow Business Park Piperell Way Haverhill**  
**Suffolk CB9 8QX**



# Contents

Overview of Washing Machine.....	1
Installing the Washing Machine.....	2
Operating the Washing Machine .....	6
Maintenance.....	15
Troubleshooting.....	17
Appendix.....	19
Products Fiche.....	21
Products Specifications .....	30

\_\_\_\_\_  
*Model number*

\_\_\_\_\_  
*Serial number*

\_\_\_\_\_  
*Date of purchase*

# SAVE THESE INSTRUCTIONS

THE MACHINE IS HOUSEHOLD USE ONLY

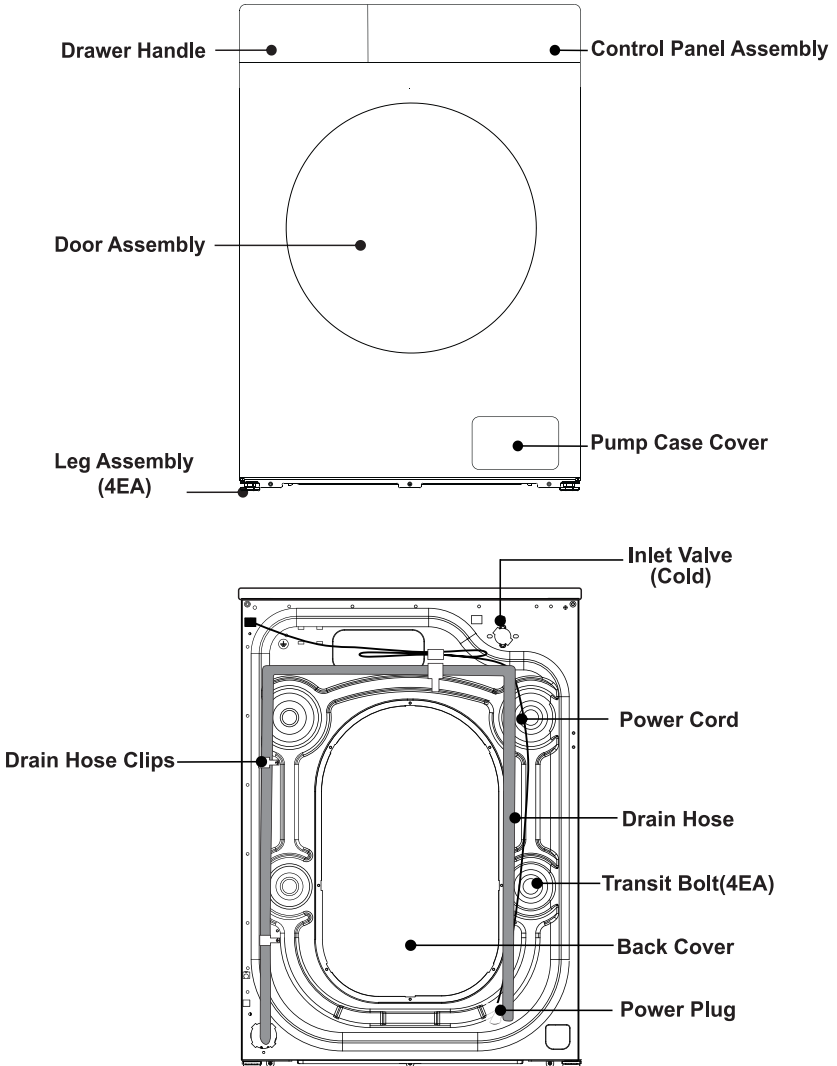

\* The illustration is a simple example of the model control panel.  
The illustration is for reference only. Please refer to the actual effect.

# Installing the Washing Machine

## NOTE

We recommend that your new washer should be installed by a qualified appliance technician. If you feel that you have the skills to install the washer, please read the installation instructions carefully before installing.





### ■ Tools needed

You may need to have the following tools to help you in the installation of your washer:

- Scissors
- Pliers
- Standard Screwdriver
- Gloves
- Spanner

### ■ Unpacking the washing machine

Unpacking your washing machine and check if there is any damage during the transportation. Also make sure that all the items (as shown below) in the attached bag are received. If there is any damage to the washing machine during the transportation, or any item is missing or damaged, please contact the local dealer immediately.

Cold Water Hose (Connect to cold water supply)	Hole Cover (4EA) (Used to plug transit bolt holes)	Drain Hose Support Bracket (Used to loop the end of drain hose)	Spanner (1. Used to adjust the bottom of the machine, 2. Remove the transport bolt on the back of the machine)
			

### ■ Select the location

Before installing the washer, the location characterized as follows shall be selected:

- Rigid, dry, and level surface (if not level, please make it level with reference to the following figure "Adjustable Leg").
- Avoid direct sun light.
- Sufficient ventilation.
- The ambient temperature shall be between 0-40°C.
- The ambient humidity shall be below 95% (When the temperature is 25°C).
- Keep far away from the heat resources such as coal or gas. Make sure that the washer will not stand on power cord. Do not install the washer on the carpet floor.

# Installing the Washing Machine

## ■ Remove transit bolts

Before using this washing machine, transit bolts must be removed from the backside of this machine. Please take the following steps to remove the bolts:

⚠ Keep the transit bolts properly for further use.

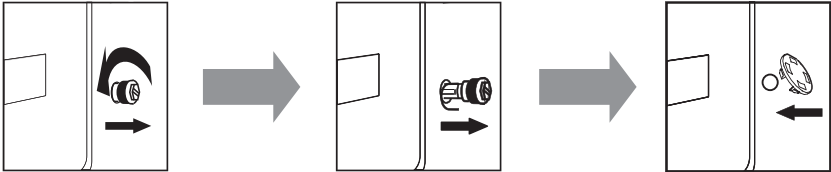

1. Loosen the four transit bolts with a spanner
2. Take each bolt head and pull it through the wide part of the hole. Repeat for each bolt.
3. Fill the holes with the supplied plastic covers.

## ■ Level the washing machine

Install or place the washing machine under the environmental temperature of not less than 0°C but not outdoors, for it may damage the programming controller.

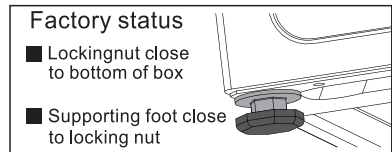
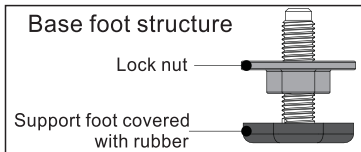

⚠ **Note:** In order to facilitate installation, the factory status of the foot may not be all locked, please be sure to lock all four feet before adjusting the level

1. When placing the machine, check whether the bottom foot is in the factory state. If not, please restore the bottom foot to the factory state: the locking nut is locked tightly on bottom of the box, and the support foot is locked tightly on the locking nut:

2. After the machine is placed, press the opposite corner of the top cover plate of the washing machine with both hands in turn and shake it vertically downward to check whether the supporting foot is close to the ground and whether the machine is shaken

3. To ensure that the machine is placed in the right state, loosen the locking nut according to the direction shown in the diagram with the attached spanner to the appropriate height until the supporting foot is close to the ground and the machine is free from shaking

4. Finally, use the spanner to turn the lock nut back to the bottom of the box to lock it (you can also slightly fix the support foot by hand to avoid the support foot moving again)

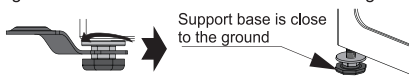

## ⚠ CAUTION

1. The machine must be perfectly leveled and stabilized when the four supporting feet are close to the ground. Lower the feet as much as possible on the basis that the machine is leveled.

2. Improper leveling adjustment may cause loud noise, machine vibrating, machine displacement and other abnormal phenomena.

3. Air-vent is designed on the bottom of the machine (prevent blockage). Install the washing machine on solid, smooth and skid-proof ground. Do not place the washing machine on soft blanket or wooden floor, or various desktops and stands, in case of unnecessary injury.

# Installing the Washing Machine

The provided water hose may differ depending on the model. Please follow the instruction according to the provided water hose.

## ■ Connect the inlet hose

Connecting to a threaded water tap

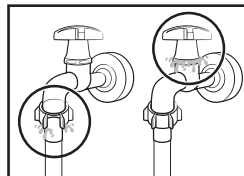
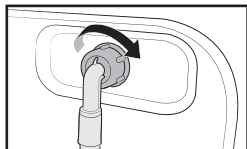
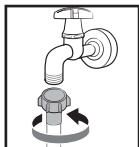

1. Connect the water hose to the water tap, and then turn the connector clockwise as shown.
2. Connect the other end of the water hose to the inlet valve on the back of the washing machine. Turn the hose clockwise to tighten.
3. Open the water tap and check if there are any leaks around the connection areas. If there are water leaks, repeat the steps above.

Connecting to a non-threaded water tap

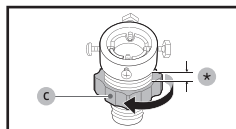
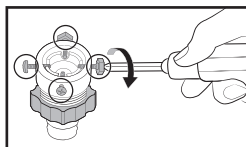
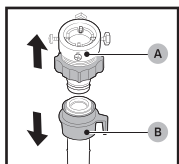

1. Remove the adaptor (A) from the water hose (B).
2. Use a Phillips screwdriver to loosen four screws on the adaptor.
3. Hold the adaptor and turn part (C) in the arrow direction to loosen it by 5mm (\*).

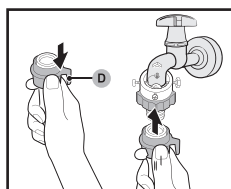
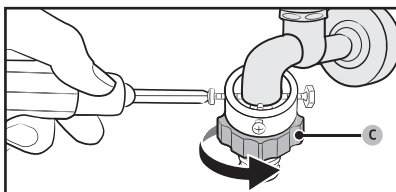

4. Insert the adaptor onto the water tap, and then tighten the screws while lifting the adaptor.
5. Turn part (C) in the arrow direction to tighten it.
6. While pulling down part (D) on the water hose, connect the water hose to the adaptor. Then, release part (D). The hose fits into the adaptor with a clicking sound.
7. To complete connecting the water hose, see 2 and 3 on the "Connecting to a threaded water tap" section.

### ⚠ NOTE

- If there is any leakage with hose after the connection, then repeat the steps to connect inlet hose.
- Do not bend the hose.
- Check for inlet hose connection carefully before using the washer each time.

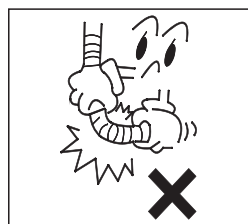

# Installing the Washing Machine

## ■ Connect the drain hose

- The drain hose shall be placed at a height of 65-100cm above the floor, otherwise, it can cause poor drainage.
- You can use the supplied drain hose support bracket to loop the drain hose down into the wall, standpipe or laundry tub.
- Take care to ensure all hose connections are tight.

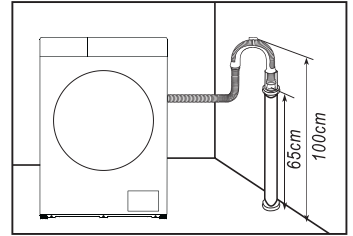
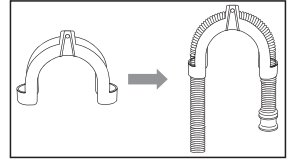

## ⚠ NOTE

- The end of the drain hose cannot be immersed in water for the washer to work properly.

## ■ Connect the power

- As the maximum current through the unit is 10A when you are using its heating function, please make sure the power supply system (current, power voltage and wire) at your home can meet the normal loading requirements of the electrical appliances.
- Please connect the power to a socket which is correctly installed and properly earthed.
- Make sure the power voltage at your plate is same to that in the machine's rated voltage.
- Power plug must match the socket.
- Do not use multi-purpose plug or socket as extension cord.
- Do not connect and pull out plug with wet hands.
- When pulling out the plug, hold the plug tightly and then pull it out. Do not pull power cord forcibly.
- If power cord is damaged or has any sign of being broken, special power cord must be selected or purchased from its manufacturer or service center for replacement.

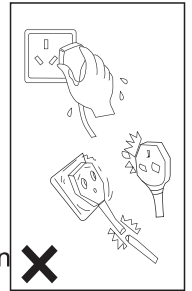

## ⚠ WARNING

1. This machine must be earthed properly. If there is any short circuit, earthing can reduce the danger of electrical shock.
2. Washing machine shall be operated in a circuit separate from other electrical appliances. Otherwise, power protector may be tripped or fuse may be burned out.



# Operating the Washing Machine

## NOTE

### Ensure your machine is installed properly before use.

Before washing clothes for the first time, you must run a complete cycle without clothes.

#### To do this:

1. Connect power source and water.
2. Put a little detergent (about 10g) into the drawer and close it.
3. Press the  **On/Off** button.
4. Turn the knob to be “ Cotton” program.
5. Press the  **Start/Pause** button.

This will remove any water from the manufacturer’s test run remaining in the machine.

### Sort clothes

Please read this recommendation carefully to avoid the troubles of washing machine and damages of clothes.

1. Do not put clothes over load the rated capacity.
2. Sort the laundry by colour and by care label. Most garments have a textile care label in the collar or side seam.
3. Make sure all the pockets are empty, Foreign objects (e.g. nails, coins, paper clips, etc.) can cause damage to garments and components in the machine.
4. Close any zips, fasten hooks etc. before washing.
5. For clothes to be washed, they should be sorted according to color. Dark clothes should not be washed with light clothes especially.
6. Badly soiled areas, stains etc. should be pre-treated with liquid detergent, stain removers etc.
7. Turn over the clothes which pill easily and is with woolen surface before putting them into the machine.

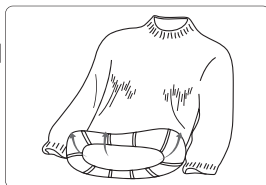
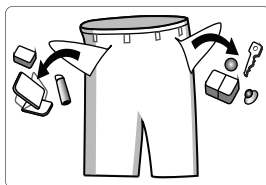

**NOTE:** Make sure that no clothes is caught between the door and the seal.

### Put detergent

- Pull out the detergent drawer.
- Add detergent for prewash into compartment I. Used only for prewash programs.

(option1:detergent that is solid; option2:detergent that is liquid.)

- Add detergent for main wash into compartment II.

(option1:detergent that is solid; option2:detergent that is liquid.)

## Operating the Washing Machine

- Add fabric softener into compartment .
- Please choose suitable type of detergent for the various washing temperature to get the best washing effect with less water and energy consumption.
- The amount of detergent/softener used should be added only once at a time. Please refer to the manufacturer's instructions for the dosage of detergent/softener.
- Excessive detergent will produce a lot of foam, easy to overflow, and will affect its dissolution, resulting in rinsing difficulties.

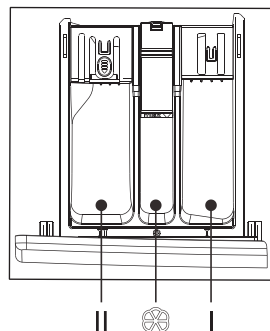

### Detergent Release(automatically release)

#### Use Liquid Detergent (Automatically)

You could add liquid detergent in box ① before washing. During operation, washing machine would add liquid detergent automatically according to the weight. It can achieve manually add once, smartly, accurately and automatically add for several times.

#### Use Washing powder or Softener(Manually)

If you would like use washing powder or softener, please push the button to close automatically add function. (The LED indicator will now be OFF) Choose non-foaming or low-foaming detergent, which are suitable for front loading washing machines.

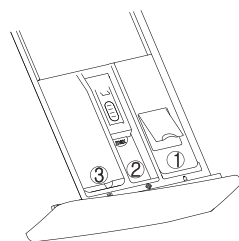

Everytime put once washing machine quantity, which could refer to manual.

Over-loading washing powder could generate a lot of bubbles. It causes difficulties for washing because of the influence of powder's dissolution. (Only applicable to models with automatic dispense function;)

- ① liquid detergent box: liquid detergent
- ② softener box: liquid softener
- ③ washing powder box: powder or liquid detergent

### NOTE

1. At the first time using liquid detergent and automatically release function, please operation "Super Quick" program to washing tube and drum.
2. It is normal that a few liquid detergent flow into down-water box when pulling liquid detergent box. Please avoid pull the box frequently to decrease the cost of liquid detergent.
3. The quantity of softener please refer to manual. Over-loading softener would destroy artificial fiber.
4. Liquid level do not over the MAX of Distributor box.
5. Please dilute the thick softener or bleach first and then release in distributor box.

# Operating the Washing Machine

## ■ Washing steps

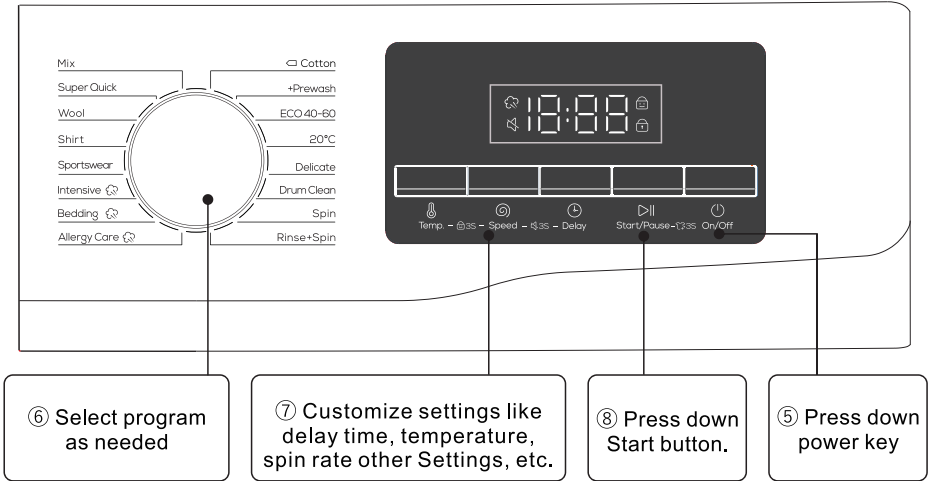
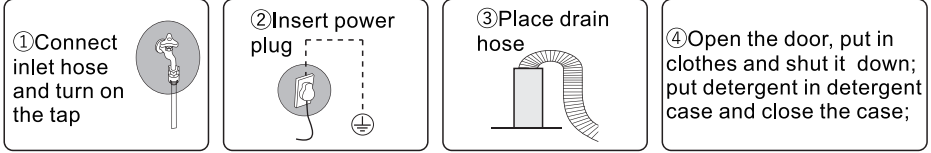





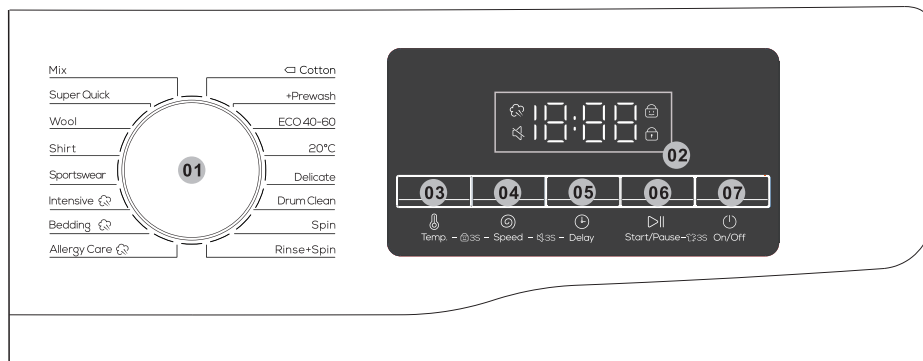

- Press Power **On/Off** to turn on the washing machine.
  - Turn the Cycle Selector to select a cycle.
  - Change the cycle settings (Temperature and Speed, etc.) as necessary.
  - Set Time Delay if you want to finish the wash cycle at the desired time.
  - Press **Start/Pause**.
- To change the cycle during operation
- Press **Start/Pause** to stop operation.
  - Select a different cycle.
  - Press **Start/Pause** again to start the new cycle.

# Operating the Washing Machine

## ■ Control panel

\* The following illustration is a simple example of the model control panel. The illustration is for reference only. Please refer to the actual effect.



01 Cycle Selector	Turn the dial to select a cycle.
02 Display	The display shows current cycle information and estimated time remaining, or an information code when a problem occurs.
03 Temp. 	Press to change the water temperature for the current cycle. Available temperature range depends on the cycle. The selected temperature will be displayed on the display.
04 Speed 	Press to change the spinning speed for the current cycle. Available spin speed depends on the cycle. The selected spin speed will be displayed on the display.
05 Delay 	Press Delay repeatedly to cycle through the available Delay options (from 3 to 24 hours in one hour increments).
06 Start/Pause 	Press to Start/Pause operation. Press the button once to start a cycle. To pause operation, press the button again. You may change the cycle settings and options. To resume paused operation, press the button again.
07 On/Off 	Press to turn On/Off the washing machine. If you turn on the washing machine and do not use it for 10 minutes, it will turn off automatically.

# Operating the Washing Machine

## Delay

You can set the washing machine to finish your wash automatically at a later time, choosing a delay of between 3 to 24 hours (in 1 hour increments). The hour displayed indicated the time the wash will finish.

1. Select a cycle. Then change the cycle settings if necessary.
2. Press **Delay** repeatedly until a desired end time is set.
3. Press **▷|| Start/Pause**.

The corresponding indicator turns on with the clock running.

4. To cancel the **Delay**, restart the washing machine by pressing  **On/Off**.

### Real-life case

You want to finish a two-hour course 3 hours later from now. For this, you add the Delay option to the current cycle with the 3-hour setting, and press **▷|| Start/Pause** at 2:00 p.m. Then, what happens? The washing machine starts operating at 3:00 p.m., and ends at 5:00 p.m.

## Steam Wash Icon

If this icon is always bright, it means the Steam Wash function is enabled. Due to the different configuration of models, some models do not have this configuration, please refer to the actual model.

## Child Lock

To prevent accidents by children, Child Lock locks all buttons except for  **On/Off**.

- To activate or deactivate the Child Lock function, press and hold **Temp.** and **Speed** simultaneously for 3 seconds.

When Child Lock is activated, the indicator  lights up.

## Alarm Off

You can turn on or off the sound of the cycle selector and all buttons.

- To turn on or off the sound, press and hold **Speed** and **Delay** simultaneously for 3 seconds. When the sound is off, the  indicator lights up.

## Door Lock

When the door is not closed or locked normally, the icon is not bright; Lock the door correctly, the icon is always bright.

## Reload

Long press the **▷|| Start/Pause** button for 3 seconds. After the lock is unlocked, the function of adding clothes in the middle can be started.

## Operating the Washing Machine

### ■ Programe

**Mix:** For mixed load consisting of cotton and synthetic.

**Super Quick:** For lightly soiled garments in less than 2.0 kg that you want to wash quickly.

**Wool:** The wool course features gentle cradling and soaking to protect the wool fibres from shrinkage/distortion. A neutral detergent is recommended.

**Shirt:** You can select this procedure to wash shirts made of cotton, linen, synthetic fibers or blended fabrics.

**Sportswear:** This procedure is applicable to the cleaning of sportswear.

**Intensive:** For heavily soiled items. The operation time is longer than other cycles.

**Bedding:** This procedure is suitable for washing heavier clothes. Jeans, bedding, etc.

**Allergy Care:** Featuring a high-temperature wash and extra rinses to help remove the remaining detergent effectively.

☐ **Cotton:** For cottons, bed linens, table linens, underwear, towels, or shirts. The washing time and the rinse count are automatically adjusted according to the load.

+ **Prewash:** Add a preliminary washing process before starting the Cotton cycle.

**ECO 40-60:** For cleaning normally soiled cotton items which are declared to be washable at 40 °C or 60 °C, together in the same cycle. This cycle is used to assess the compliance with the EU Ecodesign legislation. This cycle is set as a default.

**20°C:** New European standard special procedures, used for washing some gentle clothes, the temperature can only choose 20°C, protective clothing.

## *Operating the Washing Machine*

**Delicate:** For sheer fabrics, bras, lingerie (silk), and other handwash-only fabrics. For best performance, use liquid detergent.

**Drum Clean:** Cleans the drum by removing dirt and bacteria from it. Make sure the drum is empty. Do not use any cleaning agents for cleaning the drum.

**Spin:** Featuring an additional spin process to effectively remove moisture from laundry.

**Rinse + Spin:** Featuring an additional rinse process after applying fabric softener to the laundry.

# Operating the Washing Machine

## ■ Table of Washing Procedures

- Washing efficiency and performance is determined by used detergent quality. Use only machine wash approved detergent.
- If need use specific detergent, e.g. for synthetic and woolen fabric. Mind always detergent manufacturer recommendations.
- Do not use dry cleaning agents such as trichloroethylene and similar products. Choose the best detergent.

Program	Max Load (kg)		Kind of detergent		
	6	7	Universal	Special	Softener
Mix	4	3.5	L/P	-	○
Super Quick	1	2	L/P	-	○
Wool	2	2	-	L/P	-
Shirt	2	2.5	L/P	L	○
Sportswear	2	2.5	L/P	-	○
Intensive☁	3	7	L/P	-	○
Bedding☁	3	5	L/P	L/P	○
Allergy Care☁	2	3.5	L/P	L/P	○
☐ Cotton	6	7	L/P	-	○
+ Prewash	4	5	L/P	-	○
ECO 40-60	6	7	L/P	-	○
20°C	6	3.5	L/P	-	○
Delicate	1	3.5	L/P	L/P	-
Drum Clean	0	0	-	-	-
Spin	6	7	-	-	-
Rinse + Spin	6	7	-	-	○

L=gel-/liquid detergent P=Powder detergent O=optional -=no

If using liquid detergent, it is not recommended to activate the time delay.

We recommend by using: Laundry powder 20°C to 95°C; Wool detergent 20°C to 40°C;

\*Choose 95°C wash temperature only for special hygienic requirements.

# Operating the Washing Machine

## ■ Introduction of Other Functions

### Unlock of emergency door (not applicable in some models)

■ If you want to take out the clothes when there is a long-time power cut, make sure the water level in the drum is below the safe level, the temperature is under 40°C, and the inner drum is does not rotate, then detach the drain hose and lower it, replace the hose after water runs out;

■ Open the drain pump cover at the bottom right of the front side, pull down the rod lightly, when hearing a light sound then open the door and take out or put in the clothes;

■ Replace drain pump cover;

■ This method can only be used in emergency.

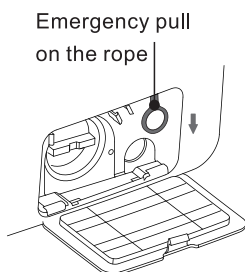

### Auto Dispensing (not applicable in some models)

■ This machine can dispense the laundry detergent automatically. When you want to use the powder detergent by yourself, please turn off the combination button to stop this function;

■ When you start the machine, if the indicator light shows full, it means the detergent is abundant; when the washing finishes, if there is only one bar of the light left, and it shows “□□□□” for the service time, it means the detergent is running out, then you need to add the detergent.

■ Before the washing, you can put the detergent in the detergent case, then the machine will dispense the detergent according to the weight of the clothes in the process of washing automatically.

■ Please find the process table for further information of the default state for this function.

### Resume Function

■ This machine has the resume function in case of power-down. If there is a power failure or plug loose in the process of machine, the machine can remember the working status and resume work when the power is restored.

### Memory Function (not applicable in some models)

■ This machine can remember the latest working process automatically. When you turn on the machine again, the machine remembers the washing process and the settings you made last time (it means the whole working process of the latest washing will be selected by default when the machine starts)

### Cloth Weigh Awareness

■ In the beginning of the washing, the machine will estimate the weight of the clothes and dispense the detergent automatically (on condition that there is enough detergent in the case), then decide the amount of the water accordingly to achieve the goal of saving water.

## Operating the Washing Machine

### Unbalance Protection

- When the machine is ready to spin, The washer may take a few time to balance clothes due to great unbalance.
- If clothes is still unbalance in the drum after that, the spinning speed can be slow down to avoid great vibration.
- If clothes in drum is too less, the machine may not to spin due to the unbalance protection, then you should add more clothes in the machine to make it to spin.

### Sprinkling (not applicable in some models)

- This machine adopts detergent auto dispensing technology; water will flow out from the detergent case to delivery detergent into inner drum. It will also spray water on the glass of observation window, which has better effect of cleaning the foam and stains on the clothed and window. This will make washing process cleaner and construct a high efficient, water-saved and clean washing environment!

### Drum lamp (not applicable in some models)

- At the beginning of the program, at the end of the program and at the pause of the washing state, the lamp of the washing machine cylinder will be lit. You can observe the situation of the clothes in the washing machine and feel the fun of smart laundry.

**Note:** Due to the product model upgrade, the function configuration may be different from this description, please take the actual model function as the standard!

## Maintenance

Proper maintenance on the washing machine can extend its work life.



**Before your maintenance starts, please do pull out the power plug or disconnect power and close the tap.**

### ■ Clean internal drum

The rusts left inside the drum by the metal articles shall be removed immediately with chlorine-free detergents. Never use steel wool.

### ■ Clean surface

- 1.If there is any water overflow, use the dry cloth to wipe it off immediately. No sharp items are allowed to strike the washer.
- 2.The surface can be cleaned with diluted non-abrasive neutral detergents when necessary.

# Maintenance

## ■ Clean the drain pump

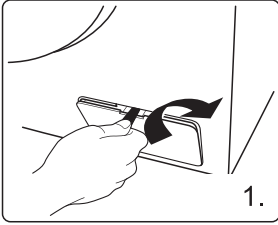

Open the filter cover with tools such as coins according to the direction of the graphic;



Unscrew the filter and pay attention to the remaining water, taking out any foreign material from the drain pump filter;

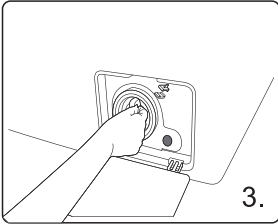
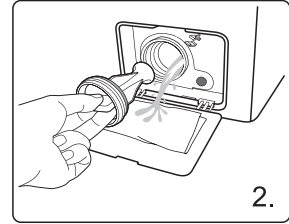

Reinstall the filter.

## ■ Clean Inlet valve filter

The inlet filter shall be cleaned if there is not any or insufficient water in when the tap is opened.

### 1. Lower the water pressure:

- a. Close the tap.
- b. Select any procedure except "Spin" procedure.
- c. Press the button "Start / Pause" and keep the procedure running for about 40 seconds.
- d. Pull out the power plug.

### 2. Remove the inlet hose from the tap.

### 3. Use water to wash the filter.

### 4. Reconnect the inlet hose.

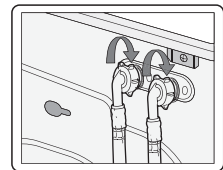
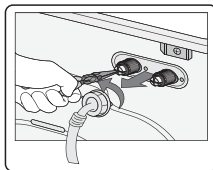
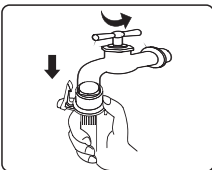

## Maintenance

### ■ Clean detergent drawer

The structure of detergent case varies from different machine models; please follow steps and methods shown in below figure to clean the detergent case:

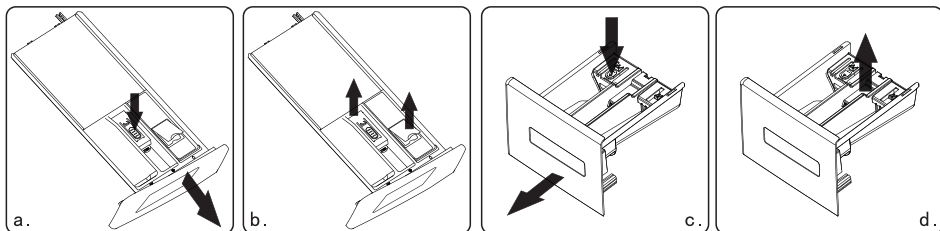

Auto dispenser

Common dispenser

#### ■ If there is detergent or softener residue in the case:

- ◆ As fig. a(c) shows, pull the case and press down the limit rod; pull the whole drawer out;
  - ◆ As fig. b(d) shows, open the case (pick it up slowly) and take out syphon plate (lift it up);
  - ◆ Use tap water or brush to wash detergent case and syphon pipe;
  - ◆ Restore case cover and syphon pipe, and push the drawer in.
- A little detergent will flow into water box when drawing the case, this is normal.

Try not repeatedly opening and closing the case of detergent loss;

■ Pay attention to the spillover of detergent that may cause inconvenience when adjusting (like tilting and moving, etc.) the machine (draw out the case before adjusting).

### ■ Recovery from freezing

The washing machine may freeze when it drops below 0°C.

1. Turn off the washing machine, and unplug the power cord.
2. Pour warm water over the water tap to loosen the water hose.
3. Disconnect the water hose, and soak it in warm water.
4. Pour warm water into the drum and leave it for about 10 minutes.
5. Reconnect the water hose to the water tap.

#### ▲ NOTE

1. When the washing machine is reused, make sure the ambient temperature is above 0°C.
2. If your washing machine is located in the room where it can get frozen easily, please drain the remaining water inside drain hose and inlet hose thoroughly.
3. Please contact a technician if your washer is frozen.

# Troubleshooting

## TROUBLES

## SOLUTIONS

There is some remaining water in the machine



This is normal and is the result of water tests performed at the factory.

The washer does not run



Check if the power plug is inserted well.  
Check if the tap is opened.  
Check if the button "Power" is pressed.  
Check if the button "Start/Pause" is pressed.  
Check if the delay feature is activated.

Water leakage



Check and fasten inlet hose.  
Clean up drain hose and ask a specialized person to repair it when necessary.

Abnormal noise and great vibration



Check if the transit bolts has been removed.  
Check if the adjustable legs are adjusted level.  
Check if the washer is installed on the solid and level floor.  
Check if there are any barrettes or metal articles inside.

Washing efficiency is not satisfied



Select a proper procedure.  
Add the proper detergent quantity according to the instructions in detergent package.

The machine take no answer after press buttons



Check if the "Child-lock" feature has been activate.  
Press button "Start/Pause" first then press other buttons.

Actually running time of procedures is not corresponded to the display time



Check if clothes in the drum is dispersive enough.  
Check if the water is drain out or inflow well.

The washer fills while draining



Check if the max height of the drain hose is lower than 65cm.  
Check if the drain hose is immersed.

# Troubleshooting





























DISPLAY	MEANS	SOLUTIONS
E1	The washer fills over time	Check if the tap is opened. Check if the water pressure is too low. Check if the inlet hose is blocked.
E2	Water drainage over time	Check if the drain pump is blocked. Contact a technician if necessary.
E3	Door lock is breakdown	Close the door well again. Check if the clothes is caught between the door and seal. Contact a technician if necessary.
E4	Water is overflowed	water automatically until the water level is suitable for wash procedure. Contact a technician if necessary.
E5	The electrical motor is breakdown	Please contact a technician.
E6	The heater does not work	Please contact a technician.
E7	There is a temperature sensor fault	Please contact a technician.
E8	Unmatched software/hardware on mainboard and frequency inverting plate	Please contact a technician.
E9	communication failures	Please contact a technician.
E10	Inverter failures	Please contact a technician.
EP	The procedure running is not corresponded to the cycle that the knob points.	Turn the cycle selector to the cycle corresponded to the procedure working on.

## Note:

Please refer to the actually purchased model for fault display here. Different models have different fault displays.

# Appendix

## ■ Fabric Care Lable

	Resistant material		Can be ironed at 100°C max	
	Delicate fabric		Do not iron	
			Item may be washed at 90°C	Can be dry cleaned using any solvent
			Item may be washed at 60°C	Dry clean with perchloride, lighter fuel, pure alcohol or R113 only
			Item may be washed at 40°C	Dry clean with aviation fuel, pure alcohol or R113 only
			Item may be washed at 30°C	Do not dry clean
	Item may be hand washed			Dry flat
	Dry clean only			Can be hung to dry
	Can be bleached in cold water			Dry on clothes hanger
	Do not bleach			Tumble dry, normal heat
	Can be ironed at 200°C max			Tumble dry, reduced heat
	Can be ironed at 150°C max			Do not tumble dry

## ■ Electrical Warning

To avoid fire, electrical shock and other accidents, please remember the following reminding:

- Only the voltage indicated in power label can be used. If you are not clear of the voltage at home, please contact the local power bureau.
- When you are using the heating function, the maximum current through the washing machine will reach 10A. Therefore, please make sure the power supply units(current, voltage and cable) can meet the normal load requirements for the machine.
- Protect the power cord properly. Power cord shall be fixed well so that it will not trip the people or other things and be damaged. Special attention shall be paid to the plug location.
- Do not make the wall-mounted socket overloaded or cable extended. Over loading of the wiring may cause fire or electrical shock. Do not pull out power plug with wet hand.
- To ensure your safety, power plug shall be inserted into an earthed socket. Carefully check and ensure that your socket is properly and reliably earthed.

### ■ Protecting the environment

- The washer is manufactured by recyclable materials. If you decide to dispose of this washer, please observe the local waste disposal regulations. Cut off the power cord so that the washer cannot be connected to power. Remove the door so that small animals and children cannot get trapped inside the washer.
- Do not exceed the detergent quantities recommended in the detergent manufactures' instruction.
- Use stain removal products and blesches before the wash cycle only when strictly necessary.
- Save water and electricity by only washing full loads(the exact amount depends upon the program used).
- Correct Disposal of this Product



This marking indicates that this product should not be disposed with other household wastes throughout the EU. To prevent possible harm to the environment or human health from uncontrolled waste disposal, recycle it responsibly to promote the sustainable reuse of material resources. To return your used device, please use the return and collection systems or contact the retailer where the product was purchased. They can take this product for environmental safe recycling.

### ⚠ NOTE:

**TWF60-S103061DA05e-EU**

1. The energy efficiency rating was tested under “ECO 40-60” procedure.
2. Scan the QR code shown on the energy label for further product information.
3. When the washing machine gives error codes, make sure you contact our after sales team to repair. We shall not be responsible for any issue caused by unauthorized repair.
4. In case you need to order the accessories, we can send out within 15 working days after the request.
5. For the purpose of improving the performance of the whole washing machine, the appearance and specifications shall be changed without additional notice.
6. CWM6KG1000: The display panel shall show “END” for 1 minutes after the cycle finish.

**CWM7KG1200:** For the purpose of improving the performance of the whole washing imachine, the appearance and specifications shall be changed without addtional notice.

# Products Fiche

CWM6KG1000	Unit	ECO 40-60			20°C	cotton 95	Wool	super quick	Intensive
		100%load	50%load	25%load					
Rated capacity	kg	6.0	3.0	1.5	3.0	6.0	1.5	1.5	6.0
duration	h:mm	3:18	2:36	2:36	0:50	2:19	0:44	0:15	2:08
energy	kWh/cycle	0.689	0.389	0.210	0.188	1.300	0.110	0.038	0.756
water	L/cycle	50.0	40.0	35.0	40.0	62.0	54.0	32.0	42.0
Max temp	°C	39	31	26	20	76	22	18	50
RMC	%	62.9	62.9	62.9	83.0	74.0	80.0	88.0	75.0
Spin Speed	rpm	1000	1000	1000	600	800	400	800	800

CWM7KG1200	Unit	ECO 40-60			20°C	cotton 95	Wool	super quick	Intensive
		100%load	50%load	25%load					
Rated capacity	kg	7.0	3.5	2.0	3.5	7.0	2.0	2.0	7.0
duration	h:mm	3:28	2:42	2:24	0:50	2:19	0:44	0:18	2:08
energy	kWh/cycle	0.862	0.538	0.272	0.180	1.460	0.110	0.040	0.780
water	L/cycle	56.0	40.0	34.0	41.0	66.0	56.0	35.0	46.0
Max temp	°C	41	37	27	20	76	20	17	50
RMC	%	53.90	53.90	53.90	83	72	78	90	75
Spin Speed	rpm	1200	1200	1200	600	800	400	800	800

# Products Fiche

Supplier's name or trade mark: Cookology

Model Identifier: CWM6KG1000

General Product Parameters:

Parameter	Value		Parameter	Value		
Rated Capacity (kg)	6.0		Dimensions in cm	Height	85	
				Width	60	
				Depth	45	
EEI <sub>w</sub>	59.4		Energy efficiency class	B		
Washing Efficiency Index	1.031		Rinsing effectiveness (g/kg)	5.0		
Energy consumption in kWh per cycle, based on the ECO40-60 programme. Actual energy consumption will depend on how the appliance is used.	0.481		Water consumption in litre per cycle, based on the ECO40-60 programme. Actual water consumption will depend on how the appliance is used and on the hardness of the water.	43		
Maximum temperature inside the treated textile (°C)	Rated Capacity	39	Remaining moisture content (%)	62.9	Rated Capacity	62.90
	Half	31			Half	62.90
	Quarter	26			Quarter	62.90

## Products Fiche

Spin speed (rpm)	Rated capacity	1000	Spin-drying efficiency class	C
	Half	1000		
	Quarter	1000		
Programme duration (h:min)	Rated capacity	3:18	Type	free-standing
	Half	2:36		
	Quarter	2:36		
Airborne acoustical noise emissions in the spinning phase(dB(A) re 1 pW)	76		Airborne acoustical noise emission class (spinning phase)	B
Off-mode (W)	0.50		Standby mode (W)	–
Delay start (W) (if applicable)	4.00		Networked standby (W) (if applicable)	–

Minimum duration of the guarantee offered by the supplier : 24months

This product has been designed to release silver ions during the washing cycle	NO
--	----

## Products Fiche

PARAMETER	UNIT	VALUE
Rated capacity for the ECO40-60 programme, at 0,5 kg intervals (c)	kg	6.0
Energy consumption of the ECO40-60 programme at rated capacity ( $E_{W,full}$ )	kWh/cycle	0.689
Energy consumption of the ECO40-60 programme at half rated capacity ( $E_{W,1/2}$ )	kWh/cycle	0.389
Energy consumption of the ECO40-60 programme at quarter rated capacity ( $E_{W,1/4}$ )	kWh/cycle	0.210
Weighted energy consumption of the ECO40-60 programme ( $E_W$ )	kWh/cycle	0.481
Standard energy consumption of the ECO40-60 programme ( $SCE_W$ )	kWh/cycle	0.810
Energy Efficiency Index ( $EEI_W$ )	–	59.4
Water consumption of the ECO40-60 programme at rated capacity ( $W_{W,full}$ )	L/cycle	50.0
Water consumption of the ECO40-60 programme at half rated capacity ( $W_{W,1/2}$ )	L/cycle	40.0
Water consumption of the ECO40-60 programme at quarter rated capacity ( $W_{W,1/4}$ )	L/cycle	35.0
Weighted water consumption ( $W_W$ )	L/cycle	43
Washing efficiency index of the ECO40-60 programme at rated capacity ( $I_W$ )	–	1.031
Washing efficiency index of the ECO40-60 programme at half rated capacity ( $I_W$ )	–	1.031
Washing efficiency index of the ECO40-60 programme at quarter rated capacity ( $I_W$ )	–	1.031
Rinsing effectiveness of the ECO40-60 programme at rated capacity ( $I_R$ )	g/kg	5.0
Rinsing effectiveness of the ECO40-60 programme at half rated capacity ( $I_R$ )	g/kg	5.0
Rinsing effectiveness of the ECO40-60 programme at quarter rated capacity ( $I_R$ )	g/kg	5.0

## Products Fiche

Programme duration of the ECO40-60 programme at rated capacity ( $t_w$ )	h:min	3:18
Programme duration of the ECO40-60 programme at half rated capacity ( $t_w$ )	h:min	2:36
Programme duration of the ECO40-60 programme at quarter rated capacity ( $t_w$ )	h:min	2:36
Temperature reached for minimum 5 min inside the load during ECO40-60 programme at rated capacity (T)	°C	39
Temperature reached for minimum 5 min inside the load during ECO40-60 programme at half rated capacity (T)	°C	31
Temperature reached for minimum 5 min inside the load during ECO40-60 programme at quarter rated capacity (T)	°C	26
Spin speed in the spinning phase of the ECO40-60 programme at rated capacity (S)	rpm	1000
Spin speed in the spinning phase of the ECO40-60 programme at half rated capacity (S)	rpm	1000
Spin speed in the spinning phase of the ECO40-60 programme at quarter rated capacity (S)	rpm	1000
Remaining moisture content for the ECO40-60 programme at rated capacity ( $D_{full}$ )	%	62.90
Remaining moisture content for the ECO40-60 programme at half rated capacity ( $D_{1/2}$ )	%	62.90
Remaining moisture content for the ECO40-60 programme at quarter rated capacity ( $D_{1/4}$ )	%	62.90
Weighted remaining moisture content (D)	%	62.9
Airborne acoustical noise emissions during ECO40-60 programme (spinning phase)	dB(A) re 1 pW	76
Power consumption in 'off mode' ( $P_o$ )	W	0.50
Power consumption in 'standby mode' ( $P_{sm}$ )	W	–
Does 'standby mode' include the display of information?	–	–
Power consumption in 'standby mode' ( $P_{sm}$ ) in condition of networked standby (if applicable)	W	–
Power consumption in 'delay start' ( $P_{ds}$ ) (if applicable)	W	4.00

## Products Fiche

Supplier's name or trade mark: Cookology

Model Identifier: CWM7KG1200

General Product Parameters:

Parameter	Value		Parameter	Value		
Rated Capacity (kg)	7.0		Dimensions in cm	Height	85	
				Width	60	
				Depth	47	
EEI <sub>w</sub>	68.9		Energy efficiency class	C		
Washing Efficiency Index	1.031		Rinsing effectiveness (g/kg)	5.0		
Energy consumption in kWh per cycle, based on the ECO40-60 programme. Actual energy consumption will depend on how the appliance is used.	0.594		Water consumption in litre per cycle, based on the ECO40-60 programme. Actual water consumption will depend on how the appliance is used and on the hardness of the water.	45		
Maximum temperature inside the treated textile (°C)	Rated Capacity	41	Remaining moisture content (%)	53.9	Rated Capacity	53.90
	Half	37			Half	53.90
	Quarter	27			Quarter	53.90

## Products Fiche

Spin speed (rpm)	Rated capacity	1200	Spin-drying efficiency class	B
	Half	1200		
	Quarter	1200		
Programme duration (h:min)	Rated capacity	3:28	Type	free-standing
	Half	2:42		
	Quarter	2:24		
Airborne acoustical noise emissions in the spinning phase(dB(A) re 1 pW)	76		Airborne acoustical noise emission class (spinning phase)	B
Off-mode (W)	0.50		Standby mode (W)	–
Delay start (W) (if applicable)	4.00		Networked standby (W) (if applicable)	–

Minimum duration of the guarantee offered by the supplier : 2 years

This product has been designed to release silver ions during the washing cycle	NO
--	----

## Products Fiche

PARAMETER	UNIT	VALUE
Rated capacity for the ECO40-60 programme, at 0,5 kg intervals (c)	kg	7.0
Energy consumption of the ECO40-60 programme at rated capacity ( $E_{W,full}$ )	kWh/cycle	0.862
Energy consumption of the ECO40-60 programme at half rated capacity ( $E_{W,1/2}$ )	kWh/cycle	0.538
Energy consumption of the ECO40-60 programme at quarter rated capacity ( $E_{W,1/4}$ )	kWh/cycle	0.272
Weighted energy consumption of the ECO40-60 programme ( $E_W$ )	kWh/cycle	0.594
Standard energy consumption of the ECO40-60 programme ( $SCE_W$ )	kWh/cycle	0.862
Energy Efficiency Index ( $EEL_W$ )	–	68.9
Water consumption of the ECO40-60 programme at rated capacity ( $W_{W,full}$ )	L/cycle	56.0
Water consumption of the ECO40-60 programme at half rated capacity ( $W_{W,1/2}$ )	L/cycle	40.0
Water consumption of the ECO40-60 programme at quarter rated capacity ( $W_{W,1/4}$ )	L/cycle	34.0
Weighted water consumption ( $W_W$ )	L/cycle	45
Washing efficiency index of the ECO40-60 programme at rated capacity ( $I_W$ )	–	1.031
Washing efficiency index of the ECO40-60 programme at half rated capacity ( $I_W$ )	–	1.031
Washing efficiency index of the ECO40-60 programme at quarter rated capacity ( $I_W$ )	–	1.031
Rinsing effectiveness of the ECO40-60 programme at rated capacity ( $I_R$ )	g/kg	5.0
Rinsing effectiveness of the ECO40-60 programme at half rated capacity ( $I_R$ )	g/kg	5.0
Rinsing effectiveness of the ECO40-60 programme at quarter rated capacity ( $I_R$ )	g/kg	5.0

## Products Fiche

Programme duration of the ECO40-60 programme at rated capacity ( $t_w$ )	h:min	3:28
Programme duration of the ECO40-60 programme at half rated capacity ( $t_w$ )	h:min	2:42
Programme duration of the ECO40-60 programme at quarter rated capacity ( $t_w$ )	h:min	2:24
Temperature reached for minimum 5 min inside the load during ECO40-60 programme at rated capacity (T)	°C	41
Temperature reached for minimum 5 min inside the load during ECO40-60 programme at half rated capacity (T)	°C	37
Temperature reached for minimum 5 min inside the load during ECO40-60 programme at quarter rated capacity (T)	°C	27
Spin speed in the spinning phase of the ECO40-60 programme at rated capacity (S)	rpm	1200
Spin speed in the spinning phase of the ECO40-60 programme at half rated capacity (S)	rpm	1200
Spin speed in the spinning phase of the ECO40-60 programme at quarter rated capacity (S)	rpm	1200
Remaining moisture content for the ECO40-60 programme at rated capacity ( $D_{full}$ )	%	53.90
Remaining moisture content for the ECO40-60 programme at half rated capacity ( $D_{1/2}$ )	%	53.90
Remaining moisture content for the ECO40-60 programme at quarter rated capacity ( $D_{1/4}$ )	%	53.90
Weighted remaining moisture content (D)	%	53.9
Airborne acoustical noise emissions during ECO40-60 programme (spinning phase)	dB(A) re 1 pW	76
Power consumption in 'off mode' ( $P_o$ )	W	0.50
Power consumption in 'standby mode' ( $P_{sm}$ )	W	–
Does 'standby mode' include the display of information?	–	–
Power consumption in 'standby mode' ( $P_{sm}$ ) in condition of networked standby (if applicable)	W	–
Power consumption in 'delay start' ( $P_{ds}$ ) (if applicable)	W	4.00

# Products Specifications

Parameter/Capacity	Inverter Motor Series	
	6kg	7kg
<b>Model</b>	CWM6KG1000	CWM7KG1200
<b>Voltage</b>	220-240V~/50Hz	
<b>Rated Power</b>	1850W	
<b>Water Pressure</b>	0.05-0.8MPa	
<b>Outer Dimension (W*D*H)mm</b>	600*450*850	595*470*850

## ■ Circuit Diagram

CWM6KG1000

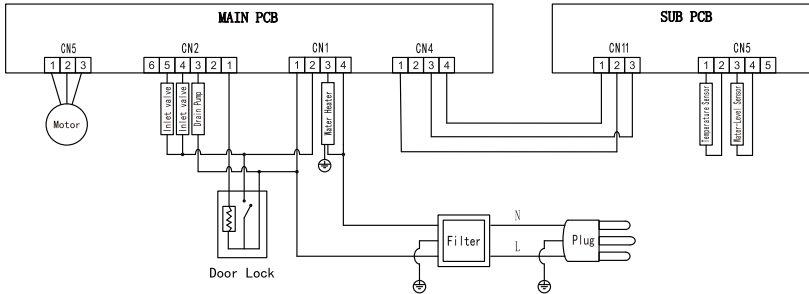

CWM7KG1200

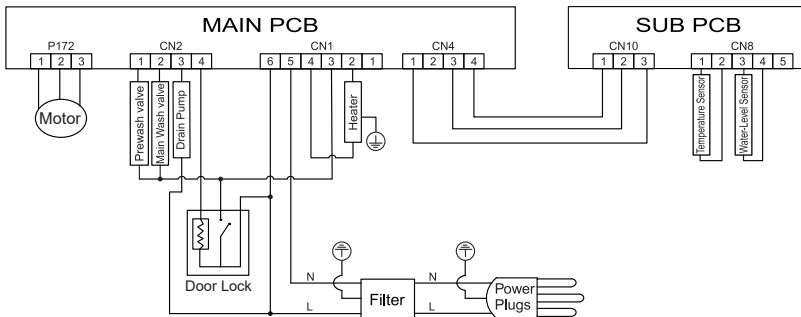

## ⚠ NOTE:

1. All the pictures in the manual are used for schematic only. It may be different from the machine you buy.
2. The actual function and the data in kind prevail.





# COOKOLOGY

OUR PRODUCTS, YOUR HOME.

Please register the warranty for this product on [www.Cookology.com](http://www.Cookology.com)

**COOKOLOGY T/A THE WRIGHT BUY LTD**  
**7 Meadow Business Park Piperell Way Haverhill**  
**Suffolk CB9 8QX**